



TECNOLOGÍA DE VANGUARDIA



POLYURETHANE

MARCH 2024



SCAN AND
DOWNLOAD

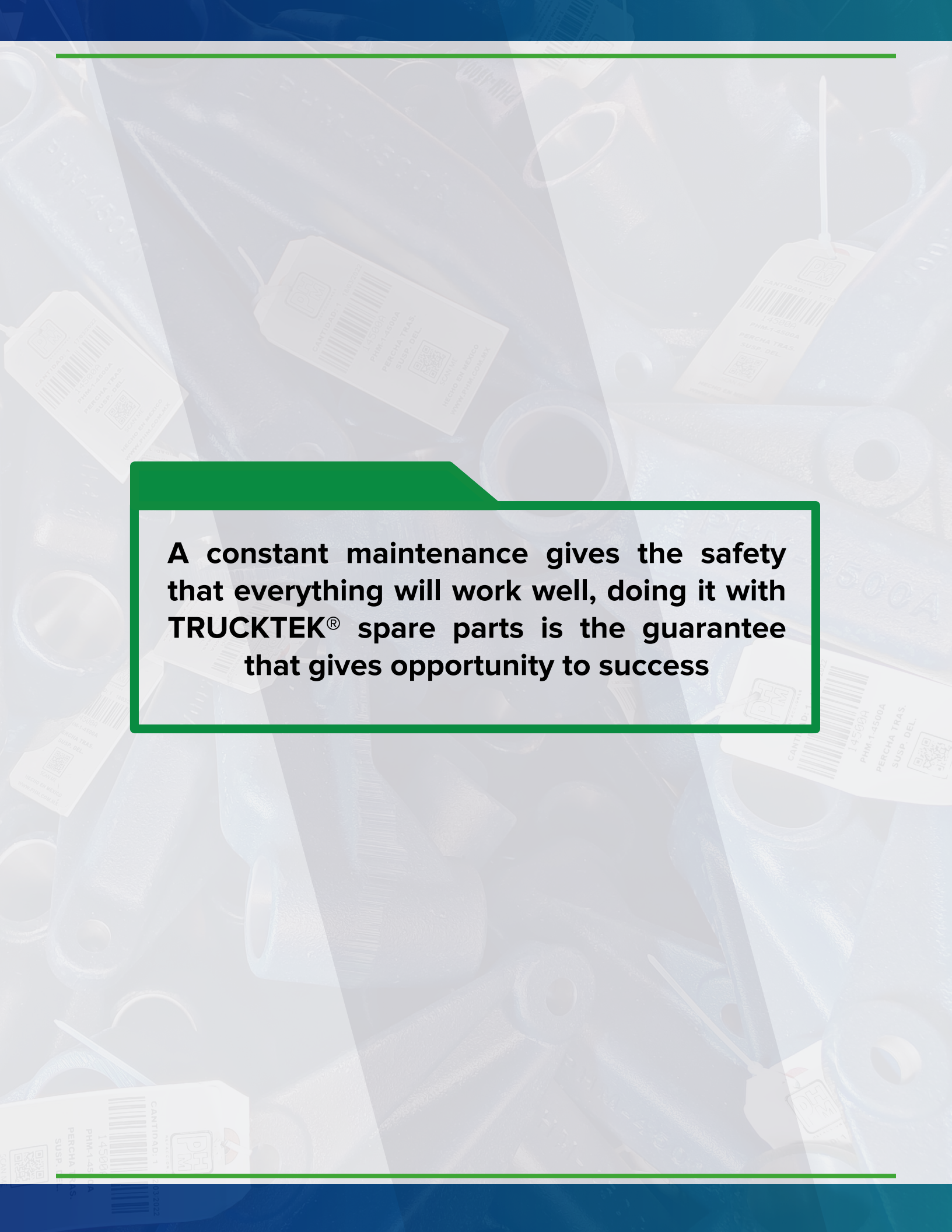

A constant maintenance gives the safety that everything will work well, doing it with TRUCKTEK® spare parts is the guarantee that gives opportunity to success

TTP18472

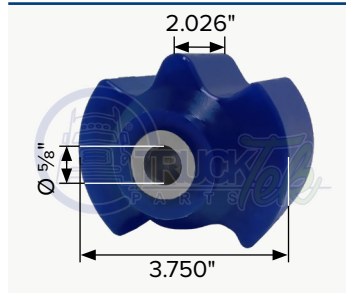

FREIGHTLINER

OEM BJ1769

Cab mount bushing

TTP0891



FREIGHTLINER

OEM A6808910001

Upper cab mount

TTPK17432

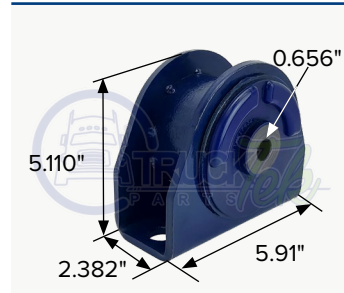

FREIGHTLINER

OEM 18-59922-000

Front cab mount assembly
Cascadia

TTP4685

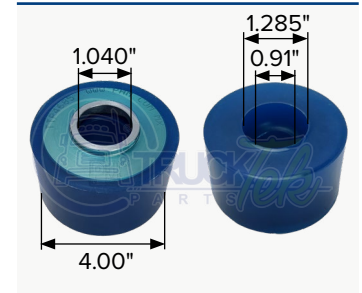

FREIGHTLINER

OEM 1853940001, M46858

Upper rear cab mount

TTP1852

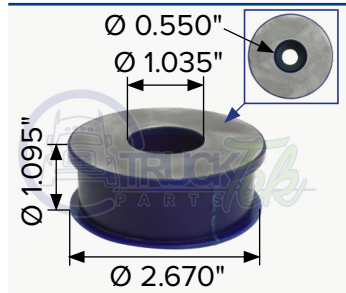

FREIGHTLINER

OEM 851852,1832297-000

Lower front cab mount

TTP3512



INTERNATIONAL

OEM 3512104C2

Cabin mount

TTP3513

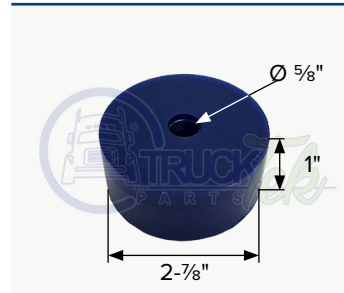

INTERNATIONAL

OEM 3512105C2

Cabin mount

TTPK3512



INTERNATIONAL

OEM 3512105C2

Cabin mount kit

TTP203074

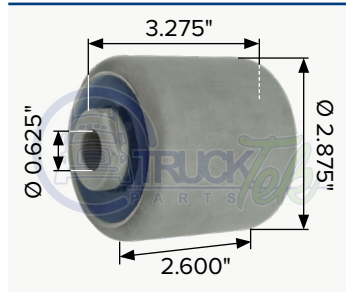

INTERNATIONAL

OEM 3595976C1, 3595976C2

Cabin mount bushing

TTP0028

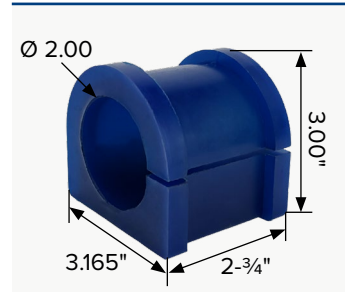

SINOTRUK, HOWO

OEM WG9925682102

Stabilizer bar bushing

TTP1875



KENWORTH

Tensioner bushing

TTP70NR



KENWORTH

OEM M30070NR

Hood/radiator mount

TTP9025



KENWORTH

OEM K066177, M50070NR

Cabin and radiator mount T-800

TTPK596651



KENWORTH

Cabin mount and rebound bushing kit

TTP596651

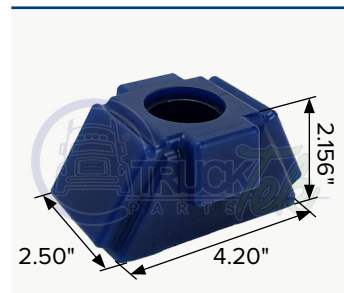

KENWORTH

OEM 2550911

Cabin mount for T800

TTP4353



KENWORTH

OEM K0664353

Rebound bushing

TTP9350

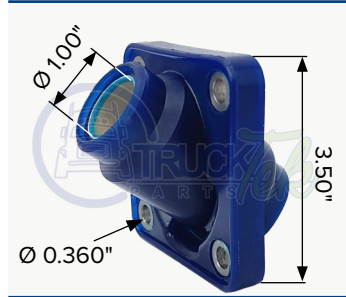

KENWORTH

OEM R131014

Steering shaft bushing

TTP3274



KENWORTH

OEM 63274

Gear lever bushing and screw set de velocidades

TTP20308

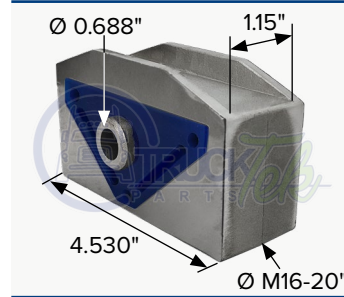

KENWORTH

OEM 2025121, 267322

Cabin mount

TTP9019

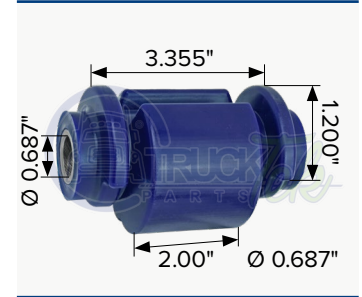

KENWORTH

OEM R626013

Hood Mount Bushing

TTP4666

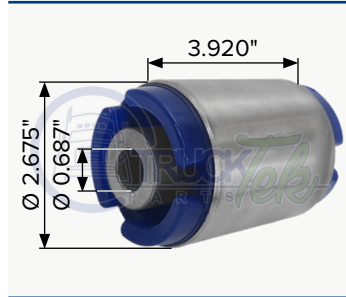

VOLVO

OEM 8074666

Cabin mount bushing

TTP0040



VOLVO

OEM 20769319

Cabin mount bracket

TTPRODILLO

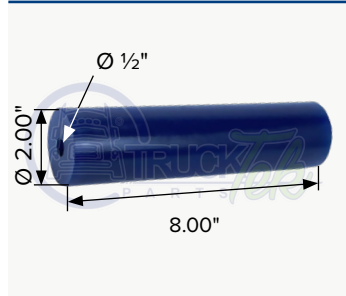

OEM

Roller

TTP2022



FREIGHTLINER

OEM A1714257-000

Hood latch bracket Coronado

TTP2023

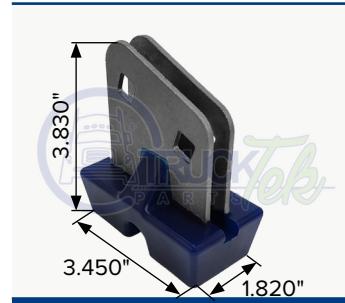

FREIGHTLINER

OEM A1715140001

Hood latch bracket Coronado

TTP9305

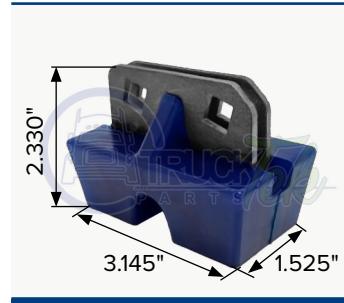

FREIGHTLINER

OEM A1713666000

Hood latch bracket Columbia

TTP4000



FREIGHTLINER

OEM A1859704, M17455

Rear mount hood support bumper Cascadia

PHM-7-9029

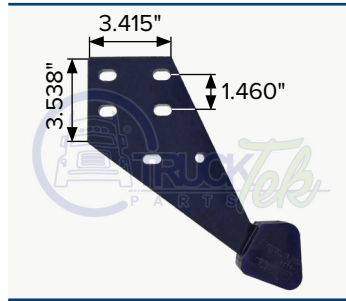

INTERNATIONAL

OEM 3548892C3

Hood guide

TTP0978L

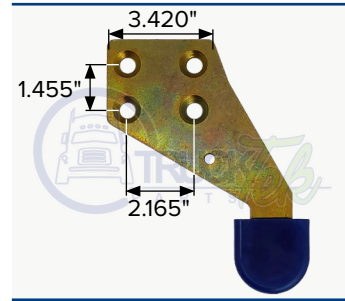

INTERNATIONAL

OEM 3810978C1

Hood guide LH

TTP0978R

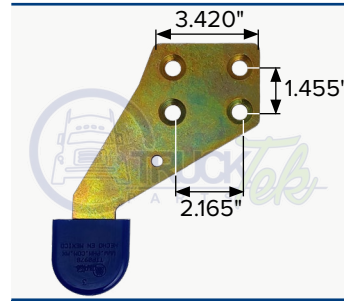

INTERNATIONAL

OEM 3810979C4

Hood guide RH

TTP3577



INTERNATIONAL

OEM 3577047C2

Hood guide

TTP0980L

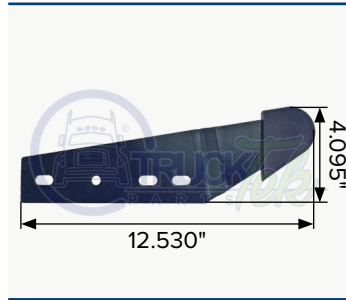

INTERNATIONAL

OEM

Hood guide IHC LH

TTP0980R

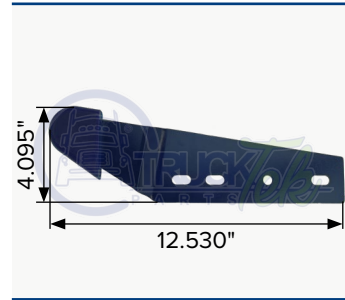

INTERNATIONAL

OEM

Hood guide IHC RH

PHM-3-9027

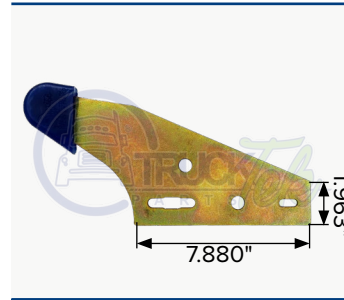

INTERNATIONAL

OEM 3559239C2

Hood guide

TTP5916L

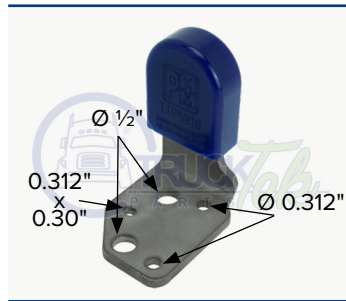

KENWORTH

OEM L85-1169, M59169R

Hood bracket LH

TTP5916R

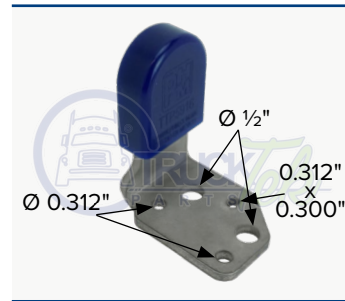

KENWORTH

OEM L85-1169R, M59169R

Hood bracket RH

TTP0027R

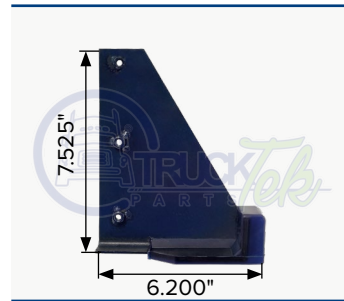

KENWORTH

OEM L85-1105R

Hood rest support LH

TTP0027L



KENWORTH

OEM L85-1105

Hood rest support RH

TTP4673

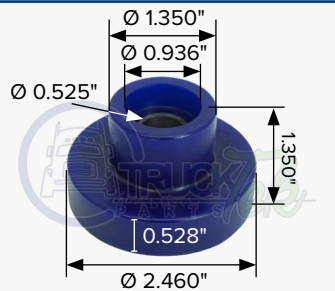

FREIGHTLINER

OEM 04-17003-000

Exhaust mount bushing

TTP9199



FREIGHTLINER

OEM J177005

Hood hinge bushing

TTP3558

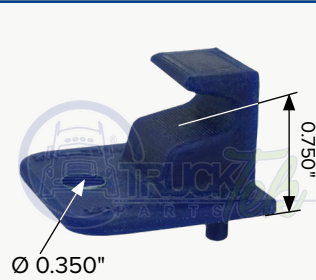

INTERNATIONAL

OEM HLK1099

Hood latch catch

TTP5570



INTERNATIONAL

OEM 3588682C1, 3544379C1

Hood bushing

TTP0049



INTERNATIONAL

OEM 3560568C2

Hood guide rest

TTP9377



INTERNATIONAL

OEM 3839700C1

Hood bumper ProStar

TTP6130

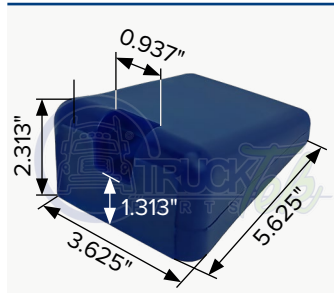

KENWORTH / PETERBILT

OEM L85-6081

Hood bumper for T680, T880

TTP6082



KENWORTH

OEM L85-6082

Hood bumper support

TTP0415

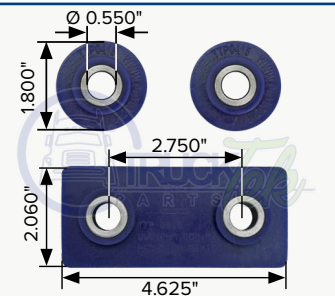

KENWORTH

OEM 13-04154, L13-6006

Hood hinge pivot bushing kit

TTP0415A

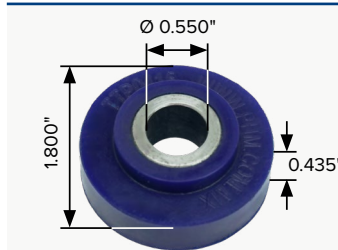

KENWORTH

OEM 13-04154

Hood hinge pivot round bushing

TTP0416

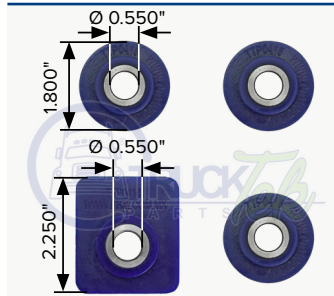

KENWORTH

OEM 13-04154, 13-04164

Hood hinge pivot bushing kit

TTP0416A

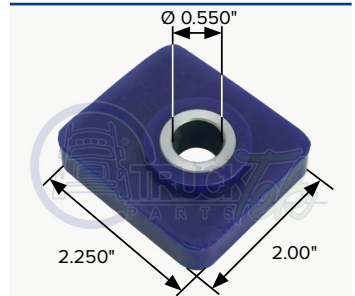

KENWORTH

OEM 13-04164

Hood hinge pivot bushing

TTP0417

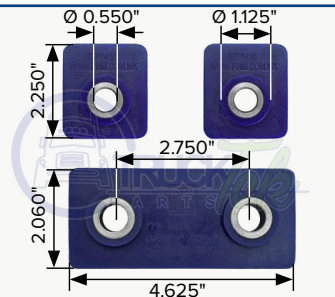

KENWORTH

OEM L13-6006, 13-04164

Hood hinge pivot bushing kit

TTP2202



KENWORTH

OEM L56-1035, HLK2202

Hood latch keeper

TTP2528

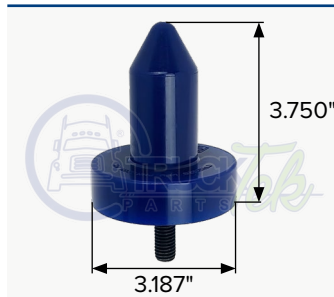

KENWORTH

OEM K179528, 25QM31

Hood mounting pin

TTP9362

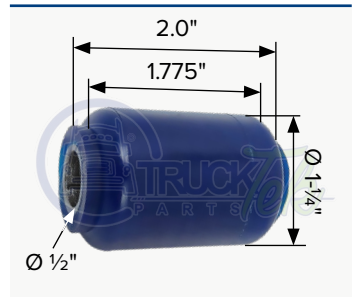

KENWORTH

Hood mount pivot bushing

TTP1878

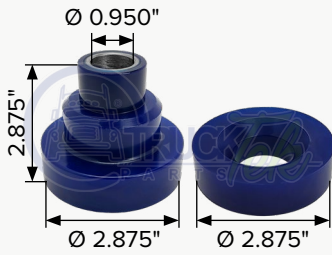

DINA

Engine mount Detroit 60 series

TTP0023

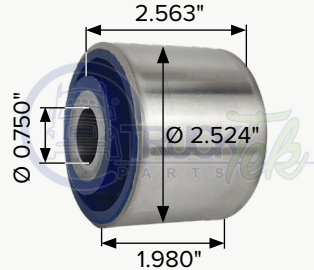

DINA

OEM 20212737
Radiator mount bushing

TTP0369

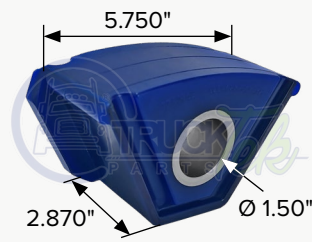

FORD

OEM F6HZ6068B, YC356068A,
M203028
Engine mount

TTP203039

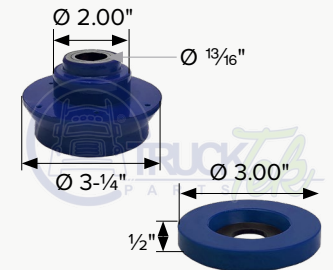

KENWORTH

OEM K066385, K066407,
K066404
Engine mount

TTP9278



FREIGHTLINER

OEM BCD-2670411, BCD-276511
Front motor mount Columbia/
Cascadia

TTP4136



FREIGHTLINER

OEM LORJ2094136
Front motor mount FLD 120,
Columbia, Century

TTP6070KIT



FREIGHTLINER

OEM 05-16070-000
Radiator mount Century,
Columbia

TTP9192

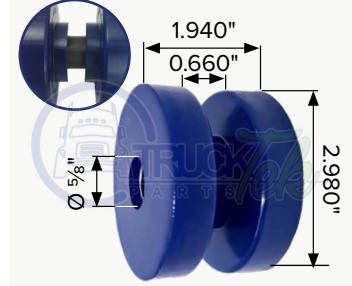

FREIGHTLINER

OEM 05-16070-000
Radiator mount Century,
Columbia

TTP9182

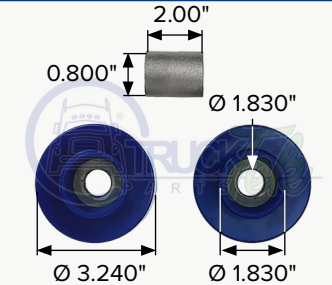

FREIGHTLINER

OEM SSB3310002
Front motor mount Century,
Columbia

TTP0039



FREIGHTLINER

OEM 0133243000
Upper rear motor mount bushing

TTP17418

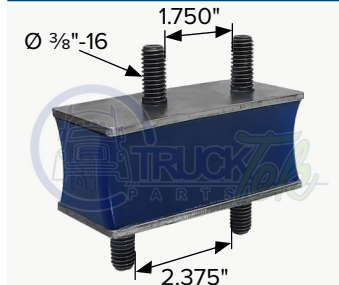

FREIGHTLINER

OEM A680504382
Lower radiator mount bushing M2

TTP7211

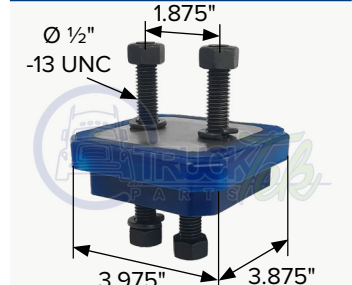

FREIGHTLINER

OEM BCD287211
Radiator mount bushing Century,
Columbia

TTP1005

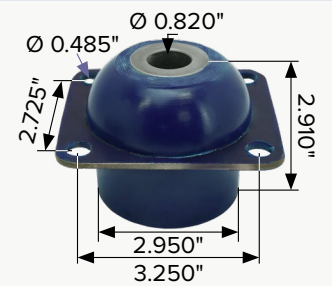

FREIGHTLINER

OEM 01-34687-000, J21113,
J211005
Engine mount isolator

TTP17398

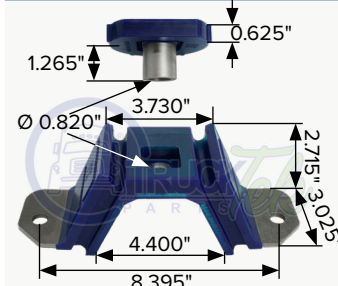

FREIGHTLINER

OEM BCD-27330-1, BCD-27330-2
Rear motor mount kit, Columbia,
Century and Cascadia

TTP17330

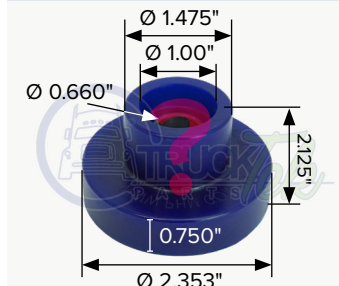

FREIGHTLINER

CBA24-650-17
Rear engine mount

TTP8528

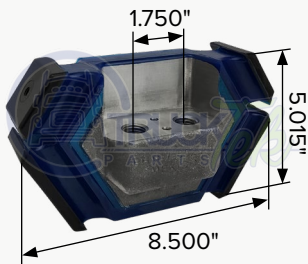

INTERNATIONAL

OEM 01-31453-00

Rear motor mount support

TTKP4723

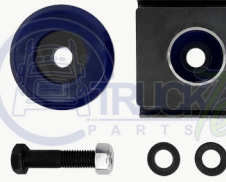

INTERNATIONAL

OEM 1664730C1

Front motor mount kit

TTP4723

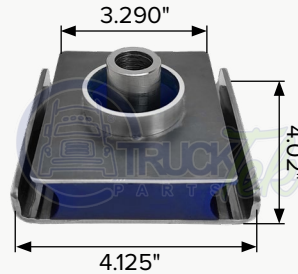

INTERNATIONAL

OEM 1664724C1, 1664724C2,
1664724C3

Front motor mount

TTP4730

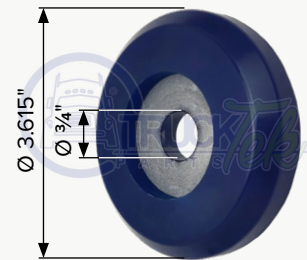

INTERNATIONAL

OEM 1664730C1

Engine mount

TTP1664



INTERNATIONAL

OEM 1664728C1, 1664728C2

Motor mount

TTPK1664



INTERNATIONAL

OEM 1664728C1, 1664728C2

Motor mount kit

TTP9169



INTERNATIONAL

OEM 3549169C1, 36459169C2,
4C4O6068BB

Motor mount kit

TTP0021

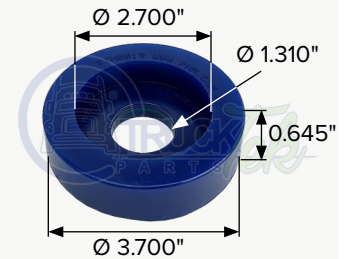

INTERNATIONAL

OEM 6802410218, J197911

Upper rear motor mount complement bushing

TTPK9197



INTERNATIONAL

OEM M17437K

Engine mount kit

TTP9197



INTERNATIONAL

OEM M17437

Rear engine mount

TTP9054

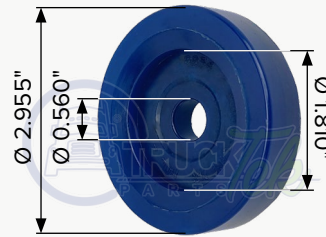

INTERNATIONAL

OEM 1664726C2

Motor mount

TTP2594

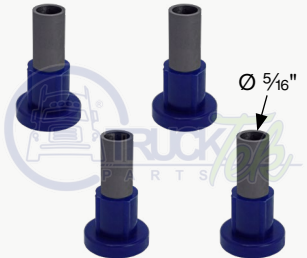

INTERNATIONAL

OEM 2594821C91

Radiator isolator kit

TTP3213



INTERNATIONAL

OEM 3560217C1, 4C4Z8A421A

Radiator mount bushing

TTP6109A

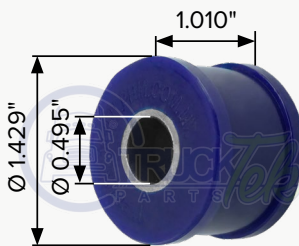

INTERNATIONAL

OEM

Clutch rod assembly bushing

TTP6109B

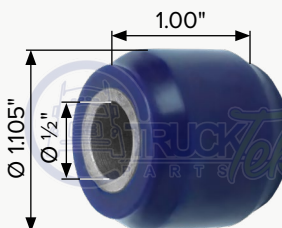

INTERNATIONAL

OEM

Clutch rod assembly bushing

TTP17411



KENWORTH

OEM K066377, K066421
Rear engine mount kit for T800, T2000

TTP6377

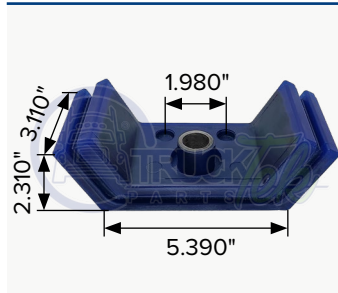

KENWORTH

OEM K066377, P06639, D1310011
Rear engine mount part for TTP6377

TTP66421

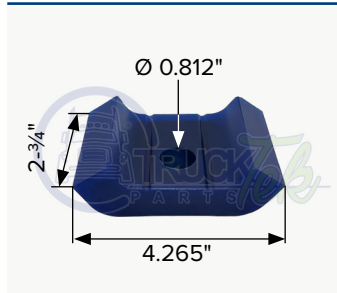

KENWORTH

OEM K066421, 261362
Rear engine mount upper part for TTP66421

TTP203039

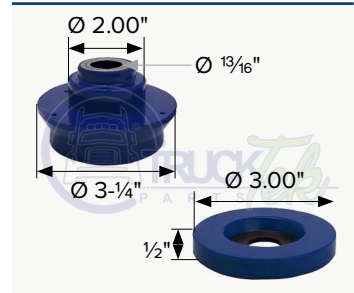

KENWORTH

OEM K066385, K066407, K066404
Engine mount

TTP6251

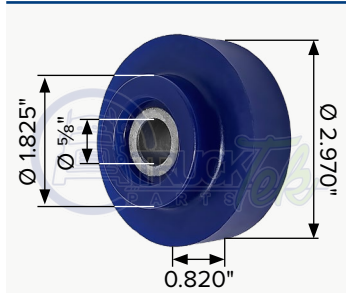

KENWORTH

OEM K066251
Radiator mount

TTP6228

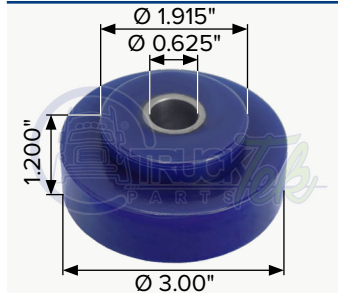

KENWORTH / PETERBILT

OEM K066-228, M60150NR
Radiator mount

TTP3662



KENWORTH

OEM K066229, 031106347
Front engine mount for T-800, W900

TTP5951

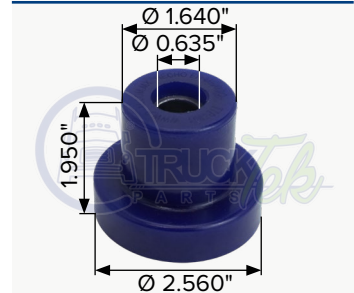

KENWORTH

OEM K066283, M50170NR
Engine mount bushing

TTP6247

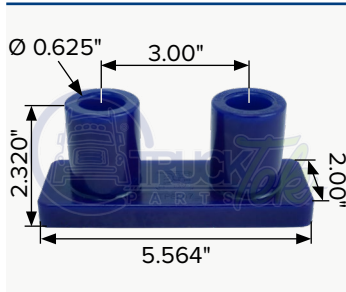

KENWORTH

OEM K066247, M50670NR
Engine mount

TTP0045

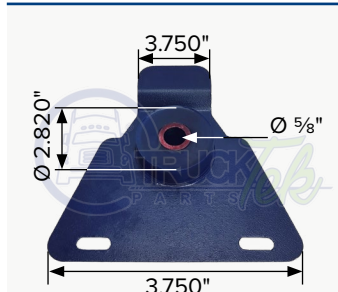

KENWORTH

Radiator bracket mount for T-2000

TTP0013

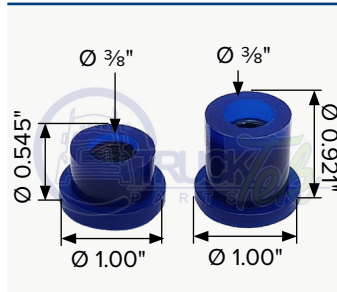

KENWORTH

Charge air cooler bushing set

TTP0014



KENWORTH

Radiator mount bushing

TTP9201

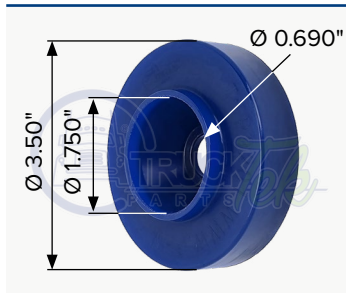

MACK

OEM 20QL312M2
Front engine mount

TTP6244

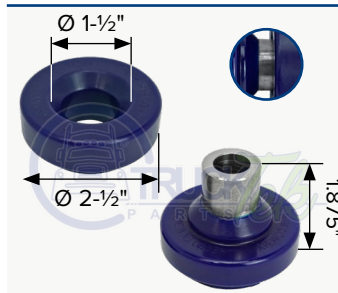

MACK

OEM CB2203105A
Radiator mount

TTP0038

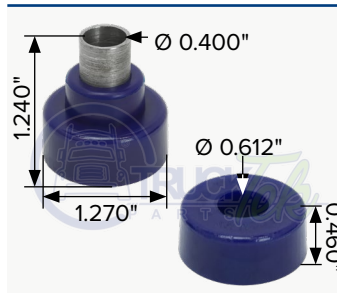

PETERBILT

OEM 1414656 CB22012
Radiator and exhaust mount

TTP8747

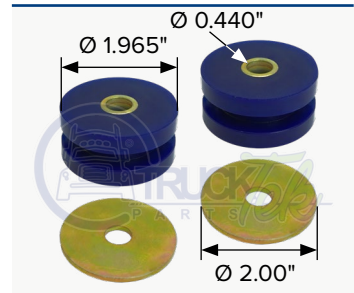

VOLVO

OEM 85108747
Radiator support kit

TTP9283

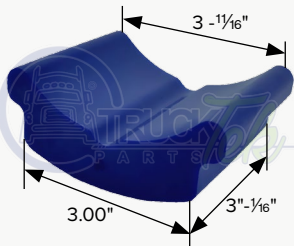

HENDRICKSON

OEM 56929

Slipper pad for PHM 14008 hanger

TTP3159

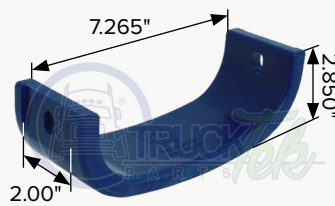

INTERNATIONAL

OEM

Wear pad for PHM 72036A and PHM 72056A hangers

espesor: 0.600"

TTP9150



INTERNATIONAL

OEM 16009001, 16002008, 571960C1

Wear pad for PHM 14001 hanger

TTP571960C1A

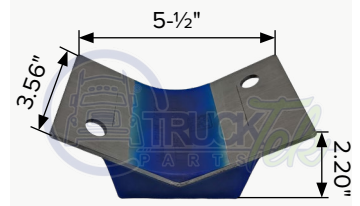

INTERNATIONAL

OEM 16009001, 16002008, 571960C1

Wear pad for PHM 14001 hanger

TTP9298

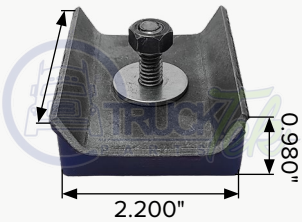

ISUZU

OEM 8972543870

Helper bracket pad

TTP0018

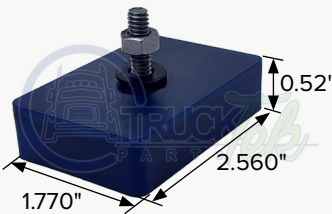

ISUZU

OEM 5004220E0-A

Helper bracket pad

PHM-7-M4810



VOLVO

OEM 8061971

Front hanger wear pad

TTPK43M



VOLVO

OEM 20703083

Rear suspension wear plate

TTP9304

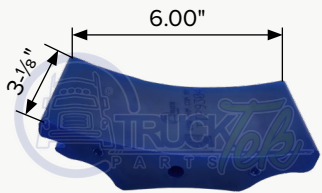

VOLVO

OEM 8079889

Leaf spring insulator pad

TTP1002



FREIFHTLINER

OEM 1615641000

Wear pad for PHM-1-7046

TTP1612



thickness: 3/16"

HENDRICKSON

OEM B11613, S11613

Wear washer

TTP1613



thickness: 5/16"

HENDRICKSON

OEM: B11613, S11613, 2588892C9

Wear washer

TTP1613A



thickness: 5/16"

HENDRICKSON

OEM:

Wear washer

TTP2122

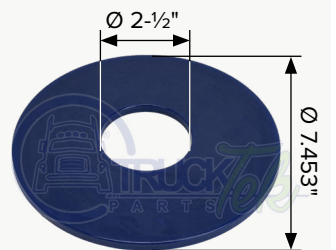

thickness: 0.250"

MERITOR

OEM 21226663

Wear washer

TTP2129

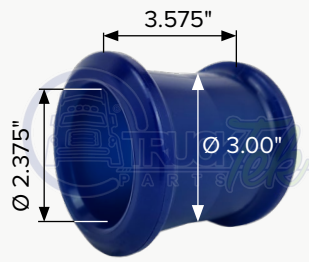

CHALMERS

OEM 22129

Torque rod bushing oversized

PHM-7-RB243



FORD

OEM RB-243

Silent block bushing

TTP0019

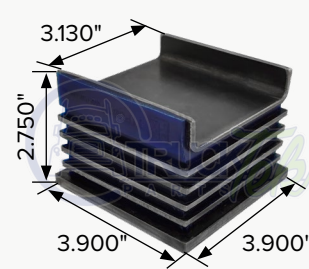

FREIGHTLINER

OEM 11-20807-000

Lower insulator Cap

TTP0020



FREIGHTLINER

OEM 1122805-000, 11-20808

Upper insulator Cap

TTP46773

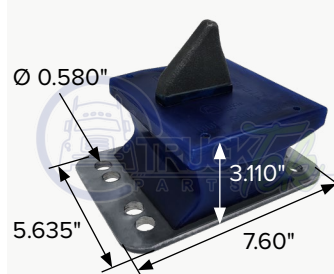

FREIGHTLINER

OEM A1615773000

Spring mount insulator front suspension M2

TTP758918

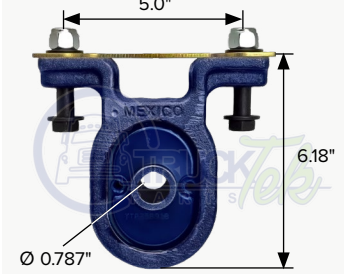

FREIGHTLINER

OEM 60961002

Front spring mount assembly kit

TTP7431

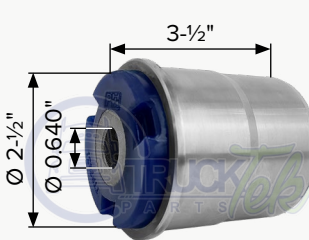

FREIGHTLINER

Cab mount bushing Business Class M2

TTP0211



FREIGHTLINER

OEM 6803220105

Silent block bushing RB211

TTP2592



FREIGHTLINER

OEM 59259002 RB301

Spring eye bushing

TTP6716

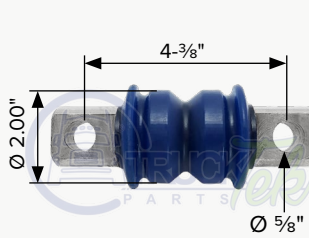

FREIGHTLINER

OEM 6813266716

Torque rod bushing FAS II

TTP3962

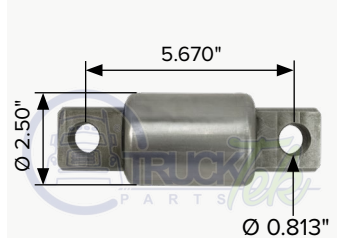

FREIGHTLINER

OEM A1613962000

Torque rod bushing

TTP6193

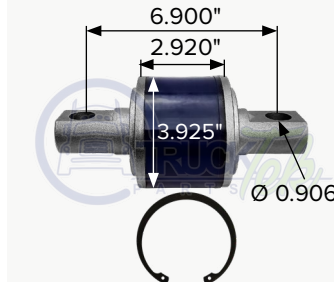

FREIGHTLINER

OEM 7048005400, WA04-3082

Bar-pin

POLÍTICA DE CALIDAD

EN PHM INNOVAMOS



FABRICAMOS



Y COMERCIALIZAMOS PARTES



ENFOCADOS EN SATISFACER
NECESIDADES Y REQUISITOS

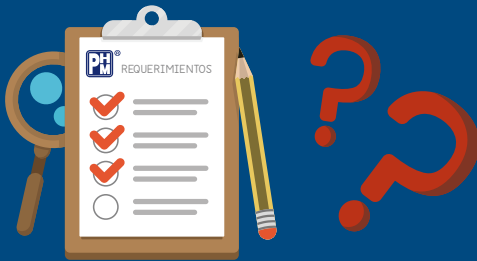

QUE APLICAN A LA INDUSTRIA
DEL TRANSPORTE DE CARGA



CON PERSONAL COMPROMETIDO
Y COMPETENTE



PARA BRINDAR VARIEDAD
SEGURIDAD Y CONFIABILIDAD



TRABAJANDO EN MEJORAR CADA DÍA NUESTROS PROCESOS.



TTP0011



FRUEHAUF

OEM UXA-0011-900
Torque arm bushing

TTP0004



FRUEHAUF

OEM UXA-004-900
Equalizer bushing

TTP2352

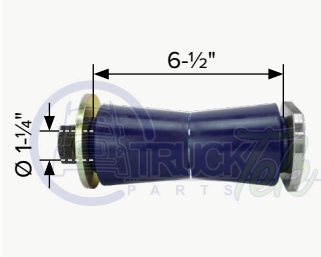

FRUEHAUF

OEM UXA000011900
Torque arm bushing kit

TTP2269

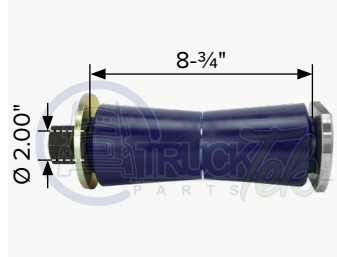

FRUEHAUF

OEM UXA-0004-900
Equalizer bushing assembly

TTP6022

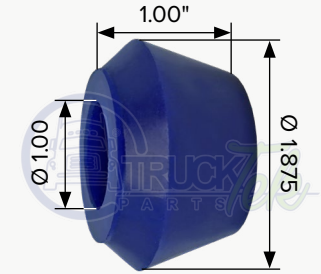

GENÉRICA

OEM 1134962
Shock absorber bushing

TTP1123



GENÉRICA

OEM
Torque arm bushing

TTP5031



HENDRICKSON

OEM 58601,0058601,55648
Quick align pivot bushing

TTP1989

Antes TTH1989

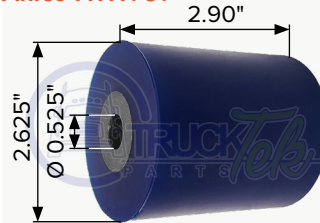

HENDRICKSON

OEM 57989000
Rebound roller bushing for HAS suspension

TTP7421



HENDRICKSON

OEM 47421
Equalizer side bushing PHM 15014

TTP9361



HENDRICKSON

OEM 47692000
Torque rod bushing for Primaax

TTP7000



HENDRICKSON

OEM 60314000
Auxiliary spring for Haulmaax

TTP9379

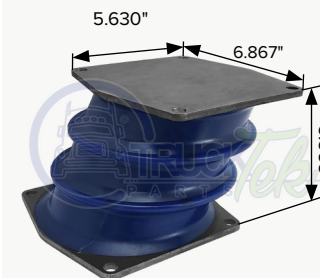

HENDRICKSON

OEM 49377, 64718000
Spring bolster

TTP9038

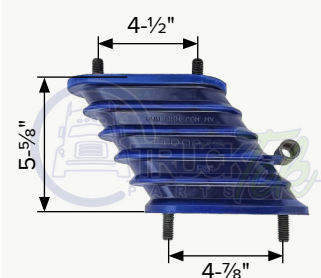

HENDRICKSON

OEM 64179-037
Tie-bar bolster spring

TTP1387

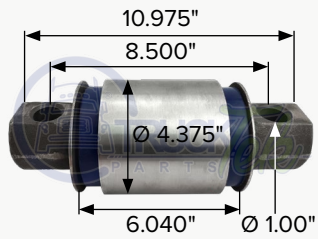

HENDRICKSON

OEM 34013088

Bar-pin lateral

TTP17691

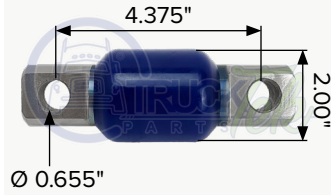

HENDRICKSON

OEM 47691

Torque arm bushing

TTP17692

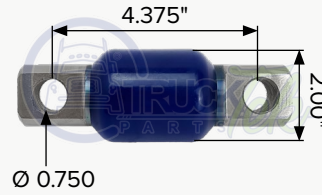

HENDRICKSON

OEM 47691

Torque arm bushing 3/4" holes

TTP3000

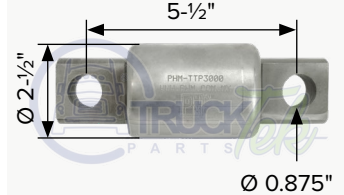

HENDRICKSON

OEM 60383000

Torque rod D-Pin bushing

TTP6440

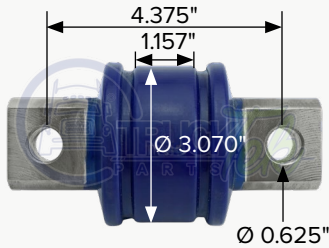

HENDRICKSON

OEM 64400005L, 64400005

Torque rod bushing

TTP64404

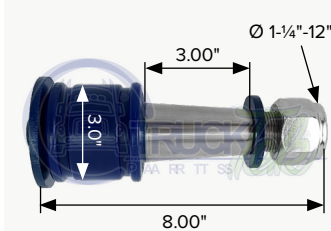

HENDRICKSON

OEM 64400004

Torque rod conical bushing 3"

TTP76366A

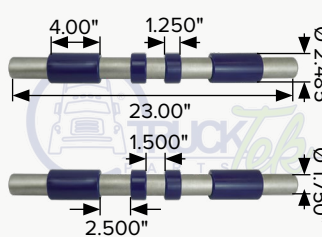

HENDRICKSON

OEM 647850078

Torque rod box bushing bars
HTB suspension

TTP13558



HENDRICKSON

OEM C3558

Tri-functional bushing for 1-1/4" bolt and wide-beam systems

TTP13559

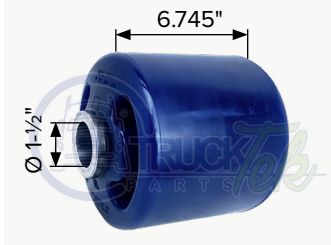

HENDRICKSON

OEM C3558

Tri-functional bushing for 1-1/2" bolt and wide-beam systems

TTP1364



HENDRICKSON

OEM D25364

Tri-functional bushing for narrow-beam systems

TTP7342



HENDRICKSON

OEM D25364

Plastic sleeve for bolt 1-1/8"

TTP1460



HUTCH

OEM 1614601

Equalizer bushing

TTP1461

Antes TTH1461



HUTCH

OEM 1614601

Equalizer bushing 1.0" pin

TTP3334



HUTCH

OEM 722-00

Torque rod bushing

TTP10123

Antes TTH10123



HUTCH

OEM 39400016

Torque rod bushing

TTP4833



Topo de rebote

TTP1300



Rear suspension stabilizer bushing

TTP4881



Front suspension stabilizer bushing

TTP1713



Spring cushion support

TTP0026



Torque rod bushing for ProStar

TTP0041



Torque rod bushing

TTP0024



Torque rod bushing

TTP5356



Rebound bushing

TTP8843



Auxiliar rear spring block

TTP0010

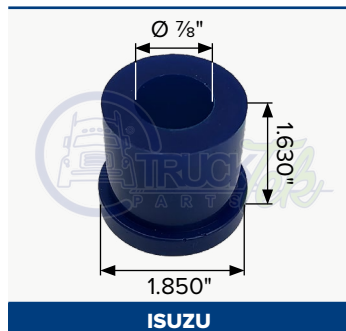

Shock absorber bushing

TTP0032



spring shackle bushing

DESCARGA NUESTROS CATÁLOGOS

HENDRICKSON
CATÁLOGO



DESCARGAME

KENWORTH
CATÁLOGO



DESCARGAME

INTERNATIONAL
CATÁLOGO



DESCARGAME

FREIGHTLINER
CATÁLOGO



DESCARGAME

PETERBILT
CATÁLOGO



DESCARGAME

FRENOS
CATÁLOGO



DESCARGAME

CATÁLOGO
AGOSTO 2018



SUSPENSIONES
REFACCIONES

Distribuidor Autorizado



DESCARGAME

PHM
SUSPENSIONES
Y REFACCIONES

TRUCK
PARTS
DEVELOPING HIGH
TECHNOLOGY PARTS

PRODUCTOS NUEVOS
ABRIL 2020



DESCARGAME



TECNOLOGÍA DE VANGUARDIA



PRODUCTOS NUEVOS

CATÁLOGO



DESCARGAME

QUINTA RUEDA

CATÁLOGO



DESCARGAME

POLIURETANO

CATÁLOGO



DESCARGAME

HULE

CATÁLOGO



DESCARGAME

HERRAMIENTAS NEUMÁTICAS

CATÁLOGO



DESCARGAME

DIRECCIÓN

CATÁLOGO



DESCARGAME

CONEXIONES

CATÁLOGO



DESCARGAME

MAZAS

CATÁLOGO

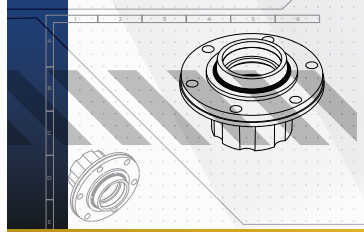

DESCARGAME

TTP640

Antes TTH640



KENWORTH

Radiator support rod bushing

TTP1321



KENWORTH

OEM K066293
Stabilizer bar bushing

TTP9181

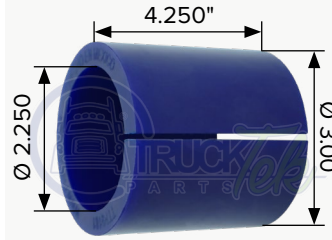

KENWORTH

OEM K066450
Stabilizer bar bushing

TTP836940

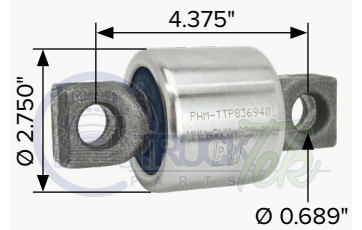

KENWORTH

OEM 836940
Buje de torsión

TTPRB249

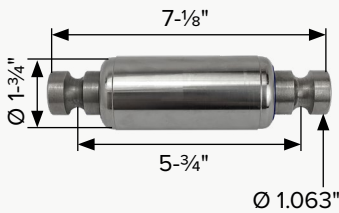

KENWORTH

OEM 50275
Spring eye hanger bushing for T2000, RB249

TTPRB295

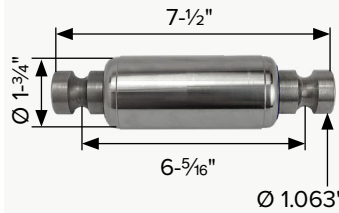

KENWORTH

OEM B651006, 52256, 52272
Spring eye hanger bushing 59-502, 59-504, 59-506, 59-518

TTPRB328

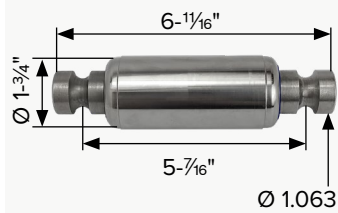

KENWORTH

OEM 52375, B656005
Spring eye hanger bushing

TTPC1360

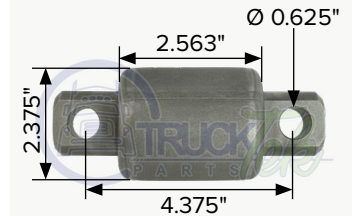

KENWORTH

OEM C136001, 51879
Torque arm bushing

TTP9010

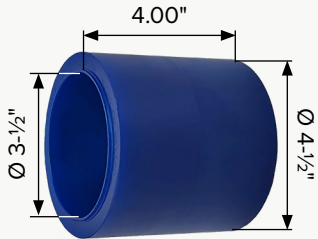

KENWORTH

OEM K066-184
Trunnion bushing for W900

TTP9011



KENWORTH

OEM K-066-232
Trunnion bushing

TTP4751



KENWORTH

OEM N4751001, EM75-61001
Air cooler mount kit for T660 Kenworth/Peterbilt

TTP8496



KENWORTH

OEM C131007
Sway bar bushing for Airglide 400

TTP21007



KENWORTH

OEM C131007
Sway bar bushing kit for Airglide 4 bushings TTP8496, 4 bolts 5/8" x 12"

TTP1032



MACK

OEM 10QK32B
Upper insulator pad

TTP9332

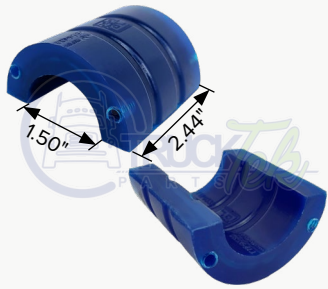

MERCEDES BENZ

OEM 6343260081

Stabilizer bar bushings

TTP9324

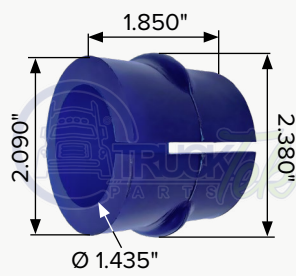

MERCEDES BENZ

OEM A9583200044

Stabilizer bar bushing

TTP40250

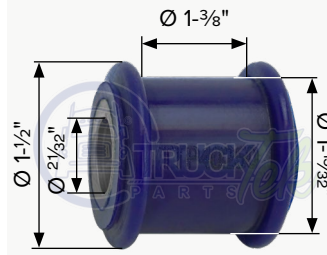

MERCEDES BENZ

OEM 3183200073

Stabilizer bar bushing

TTP0031

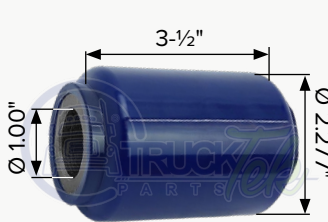

MERCEDES BENZ

Silent block bushing

TTP0015

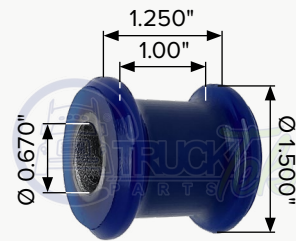

MERCEDES BENZ

Shock absorber bushing

TTP9333



MERCEDES BENZ

OEM A9743280181

Stabilizer mounting bushing

TTP9334



MERCEDES BENZ

OEM 3683200050

Stabilizer mounting bushing

TTP1416



MERITOR

OEM A1225B1692

Control arm bushing

TTP9300

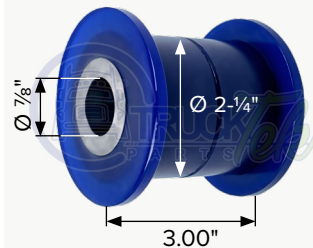

MERITOR

OEM SU99-39115

Equalizer bushing

TTP9303

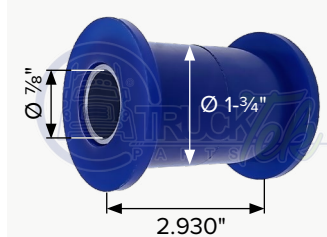

MERITOR

OEM M302500

Torque arm bushing

TTP8012

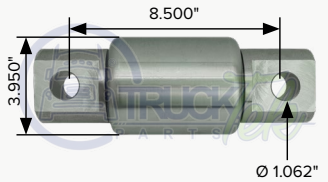

NEWAY

OEM 90508012

Bar pin center bushing

TTP8247



NEWAY

OEM 90008247

Beam pivot bushing

TTP8266



NEWAY

OEM 90008266

Beam pivot bushing

TTP8148



NEWAY

OEM 90008148, 90008149, 11223

Control arm bushing

TTP21591



NEWAY

OEM S21591, C21591, 900080008, 4KP971

Equalizer beam center bushing

TTP1202



NISSAN

OEM 5504601G00
Rear spring bushing

PHM-7-4773



PETERBILT

OEM 03AL1
Spring eye bushing kit short

PHM-7-4774



PETERBILT

OEM 03AL2
Spring eye bushing kit long

TTP0003

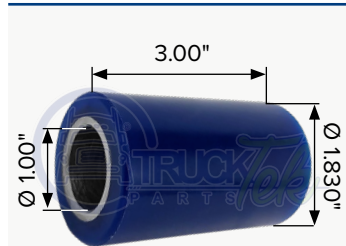

REYCO

Torque arm bushing

TTP0006



REYCO

Torque arm bushing

TTP0007



REYCO

Torque arm bushing

TTP0382



REYCO

Torque arm bushing

TTP9008B

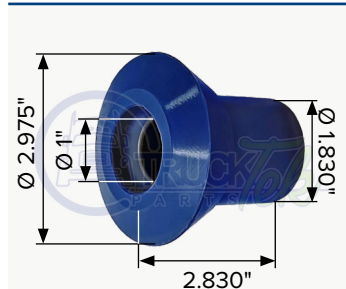

REYCO

OEM T-1842
Torque rod bushing for concentric bolt

TTP0050



REYCO

OEM T-5524
Equalizer bushing

TTP4713



REYCO

OEM 14713-01
Equalizer bushing

TTP9014B



REYCO

OEM T-2242
Torque arm bushing

TTP9202

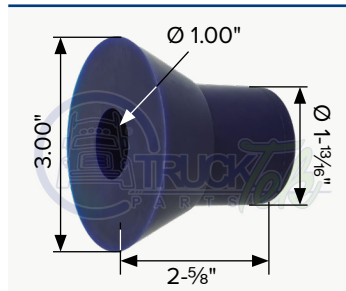

REYCO

OEM 2123801
Buje de barra de torsión

TTP0030



RIDEWELL

OEM 1117680B075, RD1175
Pivot bushing

TTP9041

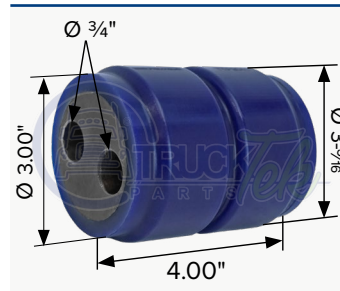

TRAILMOBILE

OEM 321-220
Equalizer bushing

TTP0091



VOLVO

Upper rear arm bushing

TTPFW009

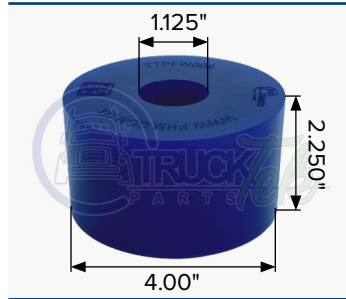

FONTAINE

OEM BSH150, KP109UB
Fifth wheel bracket bushing

TTP8575

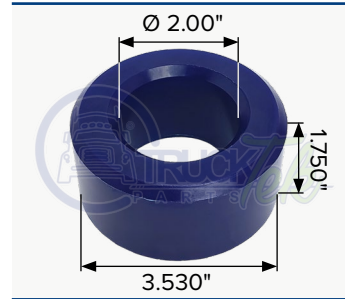

DOLLY PREMIER

OEM 344A
Dolly bushing

TTP9285



DOLLY PREMIER

OEM 348A
Dolly bushing

TTPQ001



DOLLY PREMIER

OEM 10000867
Drawbar eye bushing

TTP0605

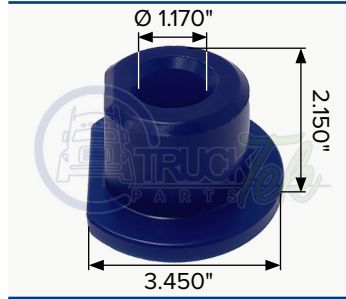

HOLLAND

OEM XB-10605
Fifth wheel cushion

TTPFW001



HOLLAND

OEM XB-00112
Cushion bushing

TTPFW005



HOLLAND

OEM XB-0011
Oval bushing

TTPFW019

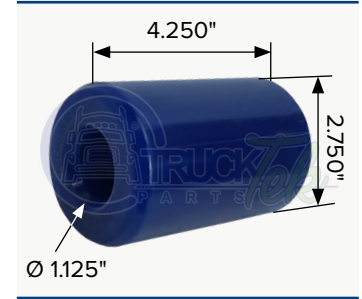

HOLLAND

OEM XA-16045
Bushing

DTTP0135

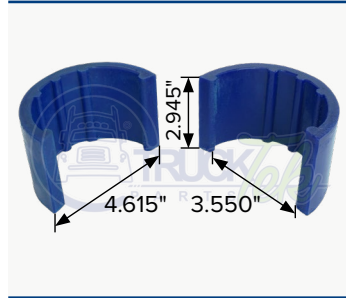

FONTAINE

OEM LNRBKT107
Bracket liner pad

TTP0052

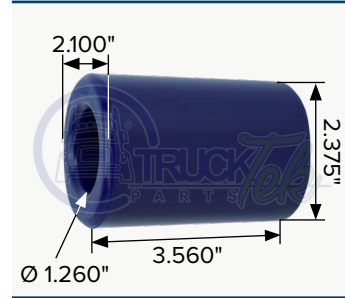

FONTAINE

OEM BSH3000
Series 3000 bushing

PHM-7-H106



OEM 380134382
6" Wrench for fuel filter vent cap

PHM-7-H108



OEM 482017
8" Wrench for fuel filter vent cap

PHM-7-H105



OEM
5" Wrench for fuel filter vent cap

PHM-7-H107



OEM
7" Wrench for fuel filter vent cap



TECNOLOGÍA DE VANGUARDIA



Carretera a Nógales #13900 km. 14 lócal 7
San Juan de Ocotán C.P. 45019
Zapopan, Jalisco
Teléfono: **3321839171**

Have you ever heard about **TRUCKTEK®**?

TRUCKTEK® manufacture and commercializes rubber and mostly poliurethane products for suspension like bushings, pins, washers, supports and other applications for your truck , always with the highest quality control standards to ensure the maximun strenght, resistance and reliability.

On **PHM®** we are exclusive distributors of **TRUCKTEK®** products, a mexicam company that shares our same values and mission.

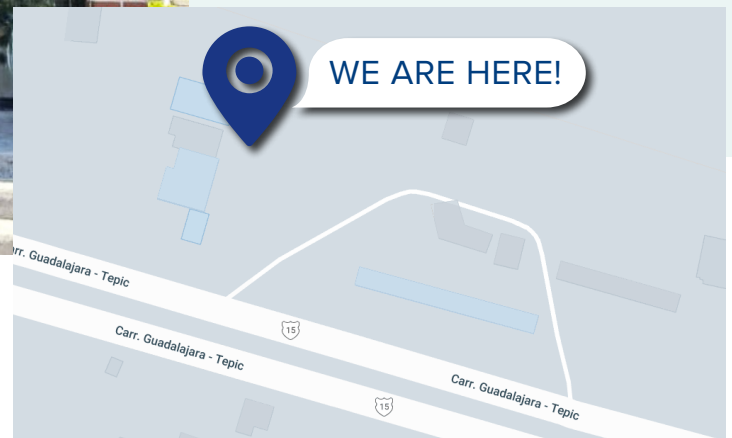

AMENDMENT

The manufacturers names and reference numbers in this catalog are only for assistance in product identification and it is not assumed that the products are from those manufacturers.

The dimensions of the product are the commercial ones and may vary slightly from the real ones.

Although special care has been taken with the veracity of the data in this catalog, TRUCKTEK® does not assume any responsibility for errors or omissions.

CONTACT US

☎ (+52) 33 3145 1011

☎ (+52) 33 3145 1884

☎ (+52) 33 3145 1876

☎ (+52) 33 1254 7813

☎ (+52) 33 1461 0175

☎ (+52) 33 2184 3148

☎ (+52) 33 2615 1393

☎ (+52) 33 1263 5401

✉ ventas@phm.com.mx

✉ contacto@phm.com.mx

🌐 <http://phm.com.mx>

