



TECNOLOGÍA DE VANGUARDIA

# RUBBER PARTS

APRIL 2024

*English*

CATALOG



SCAN AND  
DOWNLOAD



**A constant maintenance gives the safety that everything will work well, doing it with TRUCKTEK® spare parts is the guarantee that gives opportunity to success**

**TTH18472**

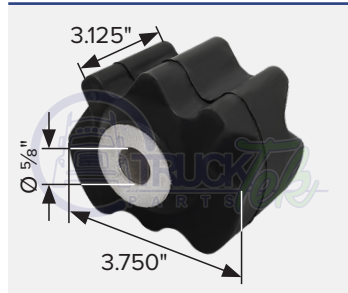

**FREIGHTLINER**

OEM BJ1769, LORDBJ17699  
Cab mount bushing Century Class (models after 2003), Columbia (models after 2003)

**PHM-2-0080H**

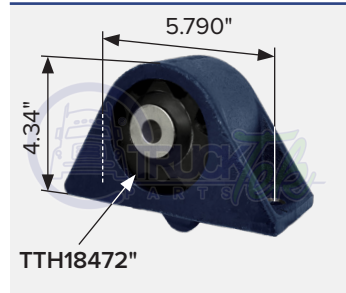

**FREIGHTLINER**

OEM 18-45384-000, A184009900  
Cab mount assembly Century Class (models after 2003), Columbia (models after 2003)

**TTHK17431**

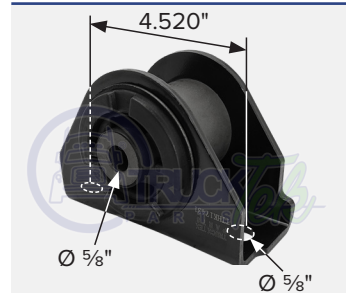

**FREIGHTLINER**

OEM 1859922000  
Front cab mount assembly Business Class M2, Cascadia, Century, Columbia, Coronado

**TTHK17432**

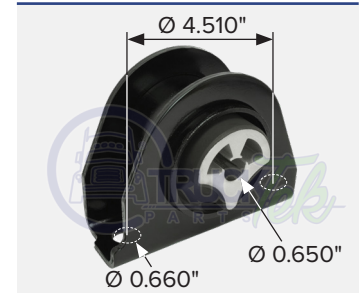

**FREIGHTLINER**

OEM 18-68767-000  
Front cab mount assembly Cascadia

**TTH7431**

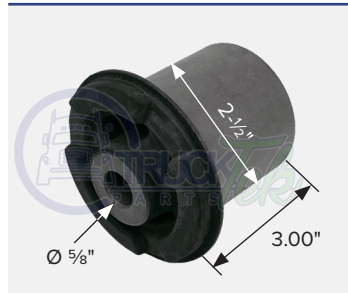

**FREIGHTLINER**

OEM 1859922000  
Cab mount bushing Business Class M2, Cascadia, Century, Columbia, Coronado

**TTH46426**

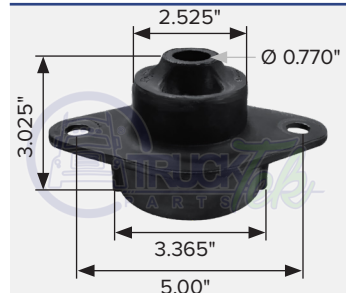

**FREIGHTLINER**

OEM 18444635000  
Rear cabin mount M2

**TT7M17431**



**FREIGHTLINER**

OEM 1845959000, 1835445000  
Cab mount bushing

**TTH6818**



**FREIGHTLINER**

OEM 18-43637-000, 681-890-00-01  
Upper cab mount kit

**TTH7427**

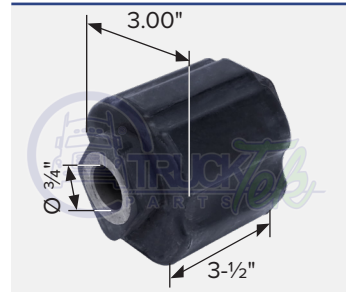

**FREIGHTLINER**

OEM 18444635000  
Front cab mount bushing Business Class M2

**PHM-3TSC1378**

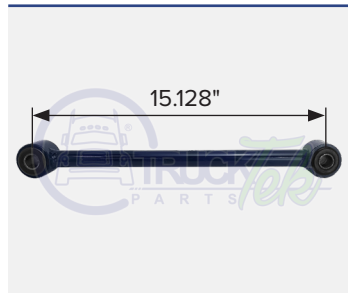

**FREIGHTLINER**

OEM 1845959000, 1835445000  
Torque rod cab

**TTH638**



**FREIGHTLINER**

OEM 1845959000, 1835445000  
Cab rod bushing



## TTH203053



**INTERNATIONAL**

OEM 3512104C2

Cabin mount

## TTH6874

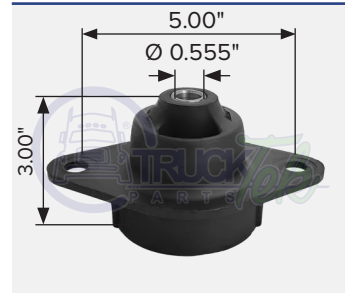

**INTERNATIONAL**

OEM 1656874C2, 14004011,

J1874837

Cabin mount insulator

## TTH203073

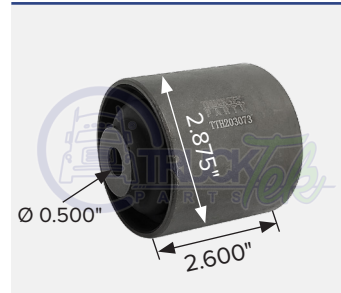

**INTERNATIONAL**

OEM 3574680C1

Cabin mount bushing

## TTH203074



**INTERNATIONAL**

OEM 3595976C1

Cabin mount bushing

## TTH596651

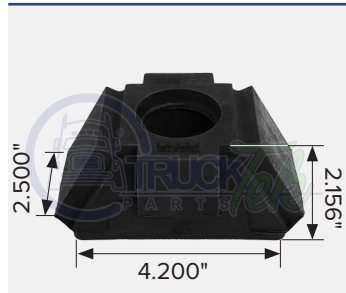

**KENWORTH**

OEM 2550911

Cabin mount for T800

## TTH4353



**KENWORTH**

OEM K0664353

Rebound bushing

## TTH70NR



**KENWORTH**

OEM M30070NR, K066218,

598699C1

Cabin mount

## TTH7414



**KENWORTH**

OEM M602, K066336, M60270NR,

M17414UB

Cabin mount

## TTH20308



**KENWORTH**

OEM 2025121, 267322

Cabin mount (Rubber)

## TTH59013

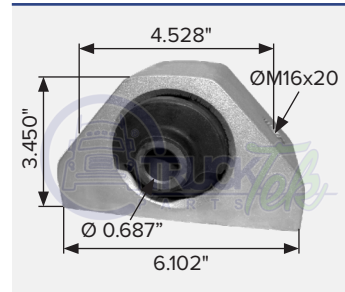

**KENWORTH**

OEM R626013

Cabin mount with bushing (Rubber), T660

## TTH59013AC

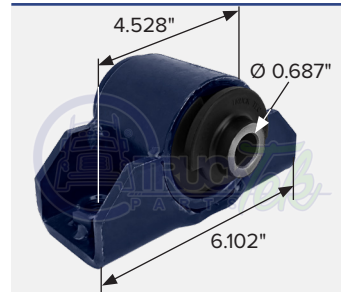

**KENWORTH**

OEM R626013

Cabin mount with bushing (Rubber), T660

## TTH9013



**KENWORTH**

OEM

Hood Mount Bushing (Rubber)

## TTH641

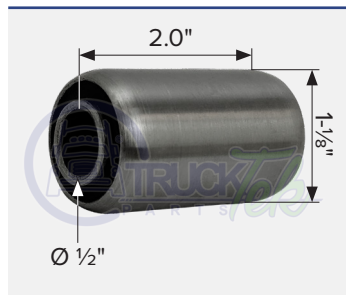

**KENWORTH**

Cabin rod bushing

Cabin rod bushing

## PHM-9-3479



**MACK**

OEM 0514794, CB112431,

660013403

Cabin support for Mack T-800

## TTH9319



**VOLVO**

OEM 20769319

Cabin support

## TTH6499



**FAMSA**

Clutch or brake pedal



**TTH2022**



**FREIGHTLINER**

OEM A1715140001, HLK2023  
Hood latch bracket Coronado

**TTH2023**



**FREIGHTLINER**

OEM A1715140000, HLK2022  
Hood latch bracket Coronado

**TTH2013LH**



**FREIGHTLINER**

OEM A1715058000  
Hood support bushing LH Business Class M2

**TTH2014RH**



**FREIGHTLINER**

OEM A1715058001  
Hood support bushing RH Business Class M2

**TTH2005**



**FREIGHTLINER**

OEM A1713666000  
Hood latch mount Columbia

**TTH4000**



**FREIGHTLINER**

OEM A1859704000, A1720868000  
Rear mount hood support bumper Cascadia

**TTP2443**

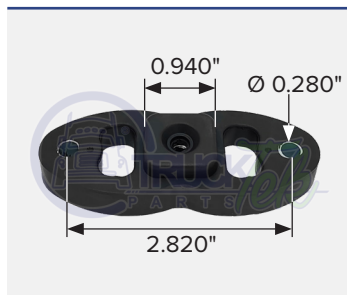

**FREIGHTLINER**

OEM A17-17256-000  
Grille mounting bracket

**TTH5340**

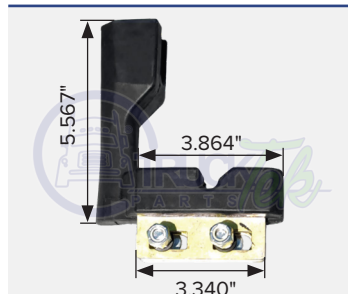

**FREIGHTLINER**

OEM A1713534000, A1713113000, A1712966000  
Hood support latch LH Century

**TTH5341**

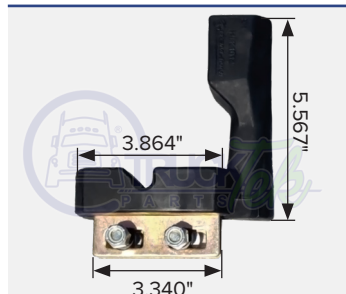

**FREIGHTLINER**

OEM A1713534001, A1713113001, A1712966001  
Hood support latch RH Century

**TT29000**



**FREIGHTLINER**

OEM A1715729000, A1715729002  
Hood support LH for Cascadia

**TT29001**

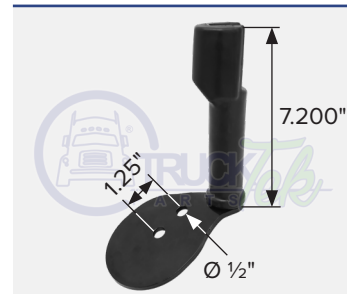

**FREIGHTLINER**

OEM A1715729000, A1715729002  
Hood support RH for Cascadia

**TTH1048**

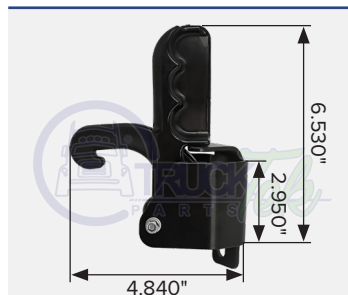

**FREIGHTLINER**

OEM A1715370000, HLK1048  
Hood support hook LH Cascadia

**TTH1049**

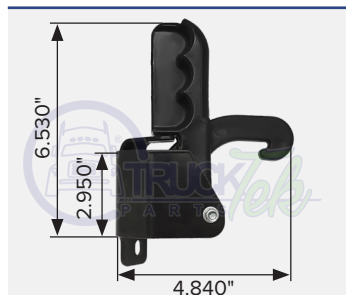

**FREIGHTLINER**

OEM A1715370001, HLK1049  
Hood support hook RH Cascadia

**TTH58002**



**FREIGHTLINER**

OEM A1712658002, A1712658000, HLK1017  
Hood support hook latch LH

**TTH58003**



**FREIGHTLINER**

OEM A1712658003, A1712658001, HLK1018  
Hood support hook latch LH

## TTH2528

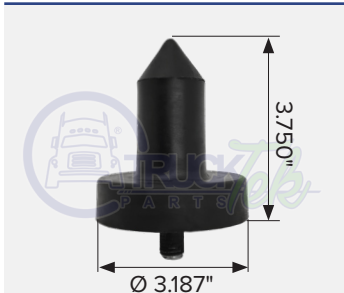

**KENWORTH**

K179528, 25QM31

Hood mounting pin

## TTP59130



**KENWORTH**

OEM L85-1130

Rear hood bumper stop

## TTH6130



**KENWORTH**

OEM L85-6081

Hood bumper support for T680, T880

## TTPK4241



**KENWORTH**

OEM K066-360

Hood roller bushing

## TTH9034B



**KENWORTH**

Hinge bushing

## TTH1062

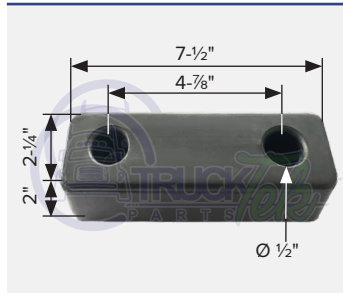

bumper stop

## TTH1067



**FORD**

Rebound bushing

## TTH1011

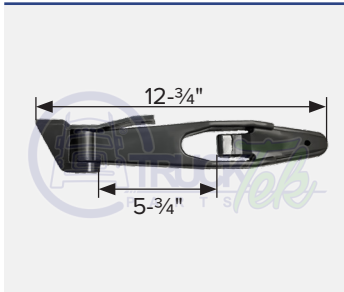

**FREIGHTLINER**

OEM 1712435000, 11104, HLK1011  
Hood latch driver LH FLD, M2

## TTH1012

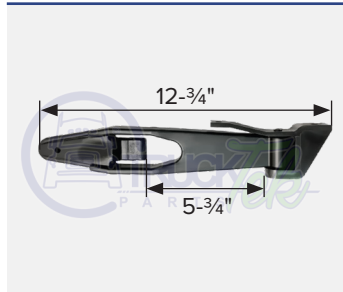

**FREIGHTLINER**

OEM 1712435001, 11105, HLK1012  
Hood latch driver RH FLD, M2

## TTH1019

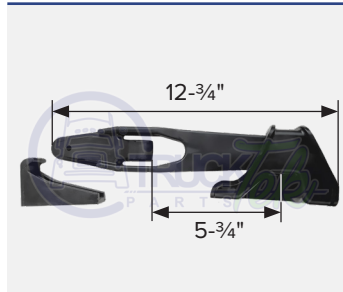

**FREIGHTLINER**

OEM HLK1019K, 171381500, A1713810002  
Hood latch driver LH Columbia

## TTH1020

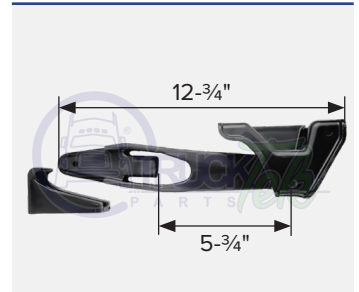

**FREIGHTLINER**

OEM HLK1020K, 171381501, A1713810003  
Hood latch driver RH Columbia

## TTH1022



**INTERNATIONAL**

OEM A1715140001, HLK2023  
Hood hook

## TTH1022L



**INTERNATIONAL**

OEM 3544925C1  
Hood hook

## TTH1702



**INTERNATIONAL**

OEM A1715058000  
Hood latch

## TTH1703



**INTERNATIONAL**

OEM 491668C92  
Hood latch Dina 500

TTH1704

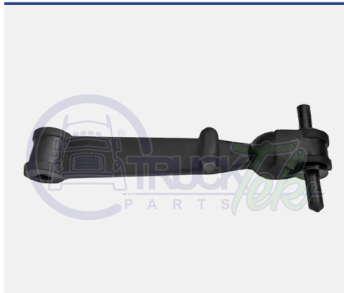

INTERNATIONAL

OEM A1713666000

Hood latch long

TTH1712



INTERNATIONAL

OEM 3530122C1

Hood latch

TTH1712D



INTERNATIONAL

Hood latch

TTH170G



INTERNATIONAL

OEM 3588682C1, 3544379C1  
Hood latch for 8500 ProStar

TTH1010



FREIGHTLINER

OEM 3839700C1

Hood latch

TTH1015



Hood latch

TTH171800



KENWORTH

OEM L566027

Hood latch

TTH171801



KENWORTH

OEM L561037

Hood latch

TTH171



KENWORTH

OEM K147107

Hood latch

TTH6114B

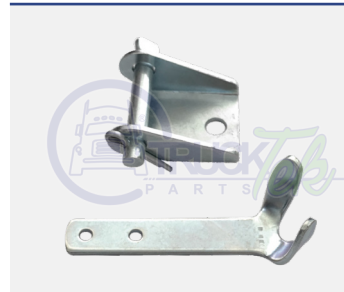

KENWORTH

Hood latch



## TTH8528

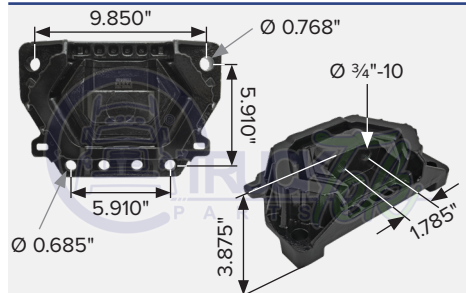

**FREIGHTLINER**

OEM J26185-28

Rear motor mount Coronado, Cascadia, Century, M2, Columbia

## TTH8528A

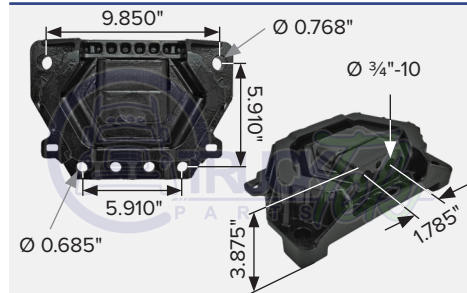

**FREIGHTLINER**

OEM 01-31453-00

Rear motor mount Coronado, Cascadia, Century, M2, Columbia

## TTH8529

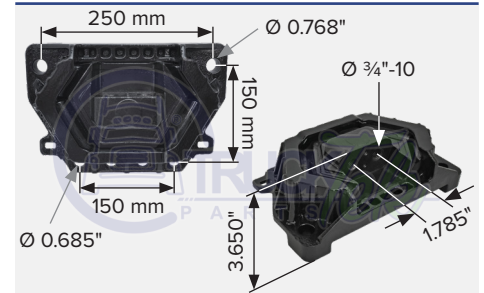

**FREIGHTLINER**

OEM J26185-29

Rear motor mount Cascadia

## TTH8531



**KENWORTH**

Motor mount support repair kit

## TTH6856

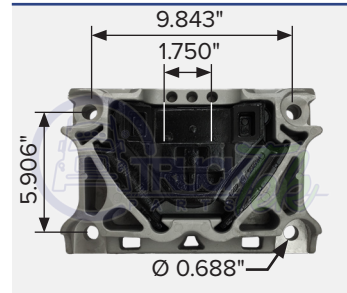

**KENWORTH**

OEM 0134095000, M46856  
Rear motor mount Cascadia

## TTH8530

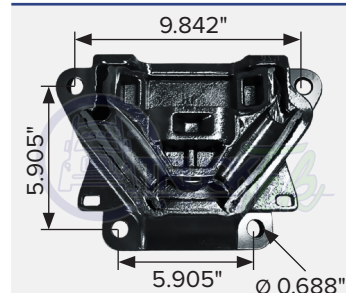

**KENWORTH**

OEM 0133928000, 30920301  
Rear motor mount Cascadia

## TTH9278



**FREIGHTLINER**

OEM BCD-2670411, BCD-276511  
Motor mount Century Class

## TTH9001



**FREIGHTLINER**

OEM J212475, J2124660  
Motor mounts upper and lower kit  
Cascadia

## TTH9002



**FREIGHTLINER**

OEM J2124721  
Motor mount Cascadia, Century, Columbia or M2

## TTH9003



**FREIGHTLINER**

OEM LORJ2124660, J2124637, J2124660  
Motor mount cascadia

## TTH9004

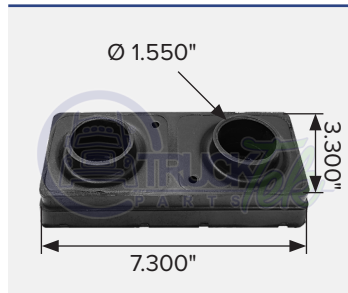

**FREIGHTLINER**

OEM J2124637, LORJ2124660  
Motor mount

## TTP9205B



**FREIGHTLINER**

OEM 753997C93  
Soporte de motor tipo Freightliner

## TTH17398

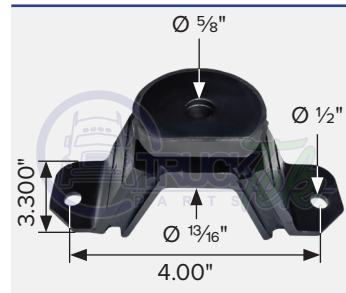

**FREIGHTLINER**

OEM MM4662001  
Rear motor mount kit Columbia, Century and Cascadia

## TTH17418



**FREIGHTLINER**

OEM A680504382, M17418  
Lower radiator mount bushing, M2

## TTH7211

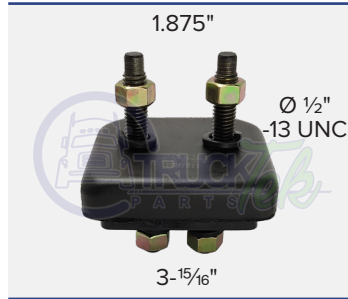

### FREIGHTLINER

OEM BCD287211, BCD288471  
Radiator mount bushing Century, Columbia

## PHM 14916

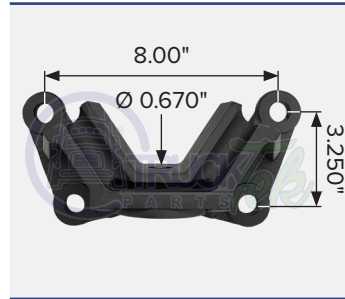

### INTERNATIONAL

OEM 3549169C1  
Motor mount

## TTH9197



### INTERNATIONAL

OEM 1664727C1  
Motor mount kit

## TTH0511



### INTERNATIONAL

Motor mount, ProStar

## PHM 2SP05A



### FREIGHTLINER

OEM 3549169C1  
Motor mount with bushing

## TT7901



### INTERNATIONAL

OEM DOHZ6068B, M20304  
Motor mount bushing

## TTH1664



### INTERNATIONAL

OEM 1664729C1  
Motor mount

## TTH7445



### INTERNATIONAL

OEM 1664730C1  
Motor mount kit

## TTH4723



### FREIGHTLINER

OEM 1664724C1  
Front motor mount, ProStar

## TTKH4730



### INTERNATIONAL

OEM 1664730C1  
Front motor mount kit, ProStar

## TTH4730

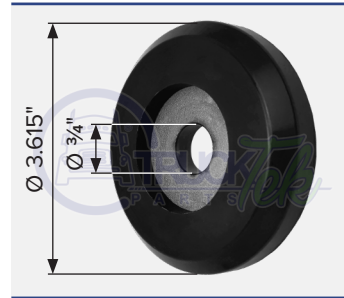

### INTERNATIONAL

OEM 1664730C1  
Motor mount

## TTH9054

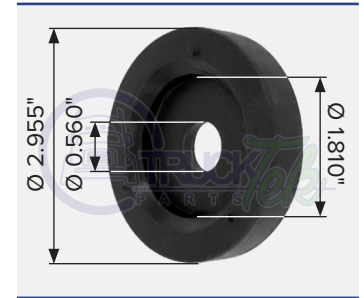

### INTERNATIONAL

OEM 1664726C1  
Motor mount

## TTH3332



### FREIGHTLINER

OEM 3824332C1  
Front motor mount

## TTH3047



### INTERNATIONAL

Engine mount

## TTH0472



### INTERNATIONAL

Famsa engine mount

## TTH0473



### INTERNATIONAL

Famsa engine mount

## TTH6275

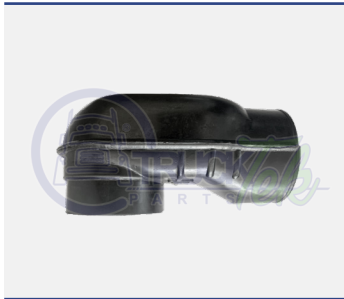

**DINA / INTERNATIONAL**

OEM 1659046C1

Intake elbow

## TT898043001

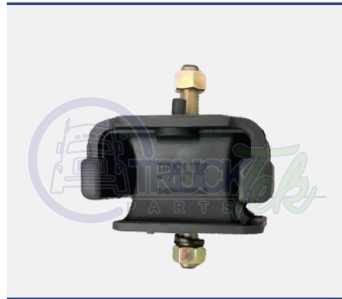

**ISUZU**

OEM 8-98043001-01

Engine mount

## TT8941720190



**ISUZU**

OEM 8-94172-019-0

Front engine mount

## TT8941119030

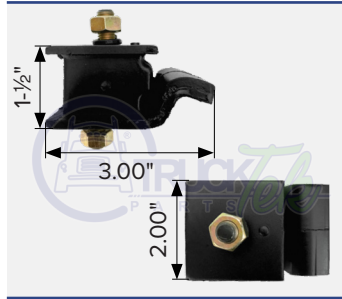

**ISUZU**

OEM 8-94111-903-0

Rear engine mount

## TT8971067580

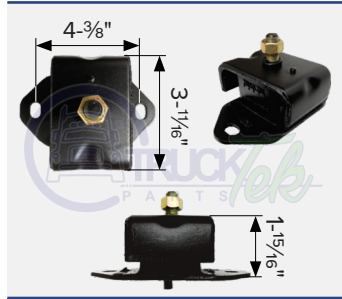

**ISUZU**

OEM 8-97106-758-0

Engine mount RH

## TT8971067590



**ISUZU**

OEM 8-97106-759-0

Engine mount LH

## TTH30026

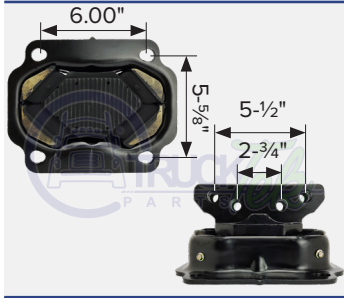

**KENWORTH**

OEM U30026

Rear engine mount for Cummins  
ISX15, T660, TT880

## TTH30027

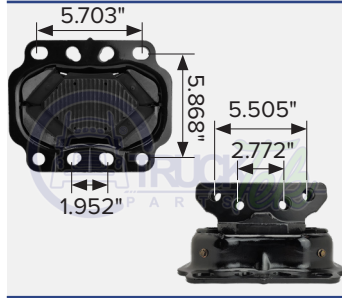

**KENWORTH**

OEM 30027

Rear engine mount for Cummins  
ISX15, T660, TT880

## TTH0087

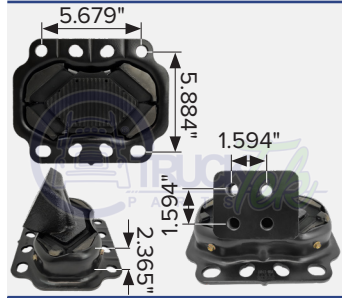

**KENWORTH**

OEM A85-1510-207

Rear engine mount LH for T880

## TTH0089

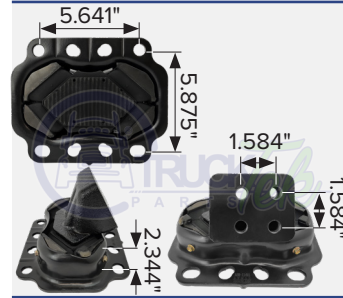

**KENWORTH**

OEM A85-1510-207R

Rear engine mount RH for T880

## TTH12446

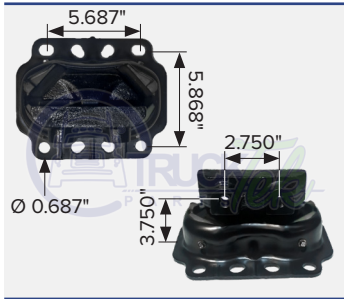

**KENWORTH**

OEM 12446

Rear engine mount for Cummins  
ISX15, T660, T800

## TTH12447

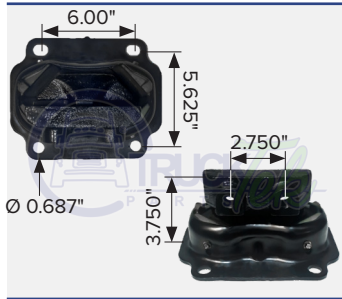

**KENWORTH**

OEM 12447

Rear engine mount for Cummins  
ISX12, T660

## TTH11681



**KENWORTH**

OEM 11681

Motor mount



## TTH10207L

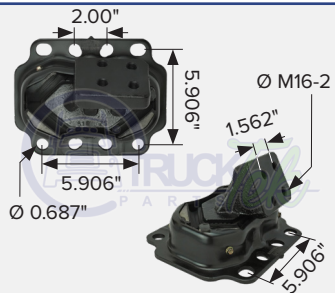

**KENWORTH / PETERBILT**

OEM A85-1510-207L

Left rear engine mount for Peterbilt

## TTH10207R

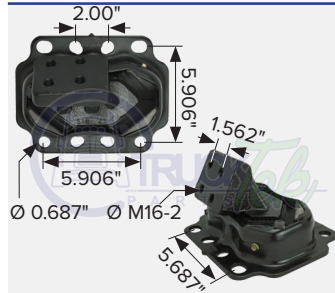

**KENWORTH / PETERBILT**

OEM A85-1510-207R

Right rear engine mount for Peterbilt

## TTH0102

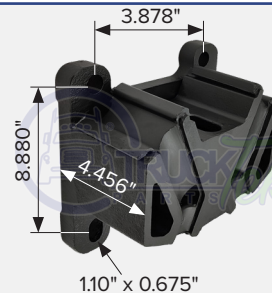

**KENWORTH / PETERBILT**

OEM 05250110102

Engine mount

## TTH203039

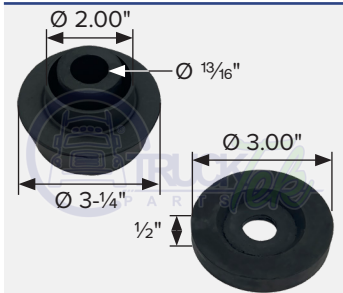

**KENWORTH**

OEM K066385, K066407

Engine mount

## TTH0825



**KENWORTH**

OEM K066229,031106347

Engine mount

## TTH6247



**KENWORTH**

OEM K066247, M50670NR

Engine mount

## TTH3662



**KENWORTH**

OEM K066229,031106347

Front engine mount for T-800, W900

## TTH3662B

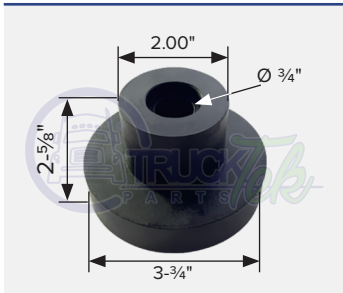

**KENWORTH**

OEM K066229,031106347

Front engine mount for T-800, W900

## TTH66421

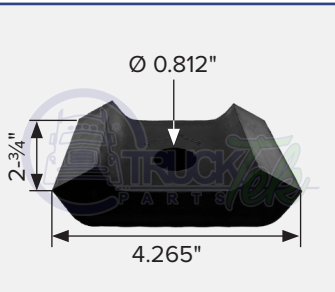

**KENWORTH**

OEM K066421, 261362

Rear engine mount part for TTH6377 for T800, T2000

## TTH6377

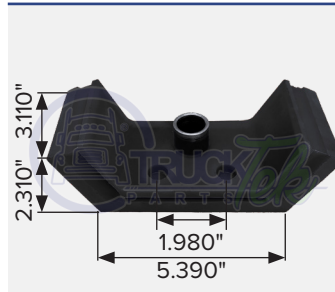

**KENWORTH**

OEM K066377, P06639, D1310011 Rear engine mount upper part for TTH66421 for T800, T2000

## TTH17411



**KENWORTH**

OEM K066377, P06639, D1310011 Rear engine mount kit for T800, T2000

## TTH6259



**KENWORTH**

Reducer hump hose 4" x 5-1/2"

## TTH6245

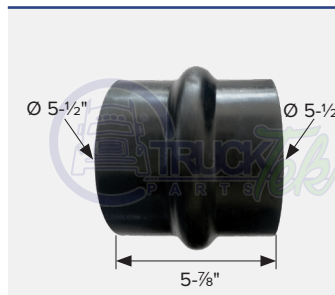

**KENWORTH**

Hose hump 5-1/2" x 5-1/2"

## TTH6240



**KENWORTH**

Hump hose 90° 5-1/2" x 5-1/2"

## TTH9010

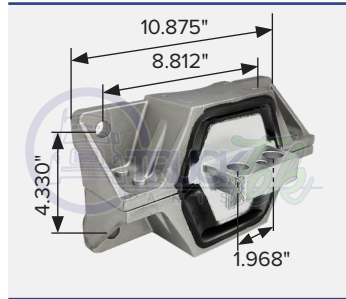

**MACK**

OEM 20QL47AM, 20QL47M, 25070943

Engine mount

## TT7911B



**MERCEDES BENZ**

OEM 3522400417  
Front engine mount

## TTH4209



**MERCEDES BENZ**

OEM 1611420-9  
Engine mount

## TTH5713



**MERCEDES BENZ**

OEM 9412415713  
Engine mount

## TTH0013

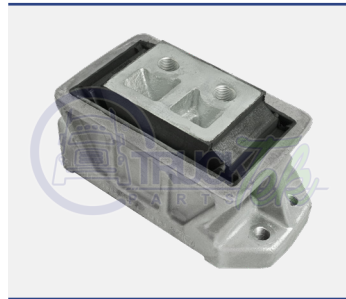

**KENWORTH**

OEM 0340240013  
Engine mount

## TTH9614



**VOLVO**

OEM 1629614, 3198122, 1076510  
Engine mount

## TTH3550

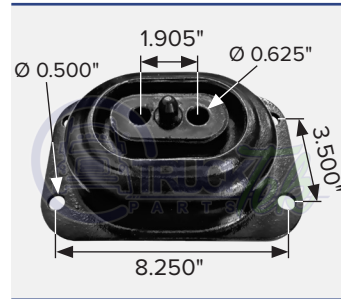

**VOLVO**

OEM 20503550, 1622836  
Engine mount

## TTH9469

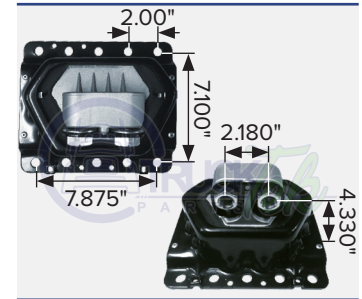

**VOLVO**

OEM 20499472, 20QL414M, J260418  
Engine mount

## TTH9992

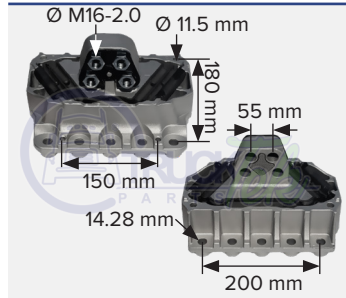

**VOLVO**

Engine mount

## TTH6249



Hose hump 3" x 3"

## TTH6250



Hose hump 3-1/2" x 3-1/2"

## TTH6254



Reducer hump hose 5-1/2" x 5"

**TTH0004**



**FRUEHAUF**  
OEM UXA004  
Equalizer bushing, F-Series

**TTH0011**



**FRUEHAUF**  
OEM UXA0011  
Tensioner bushing, F-Series

**TTH6191**

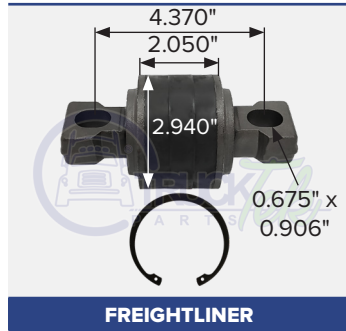

**FREIGHTLINER**  
OEM 62480041000, A237903  
Torque V-Rod end bushing kit (with snap ring)

**TTH6193**

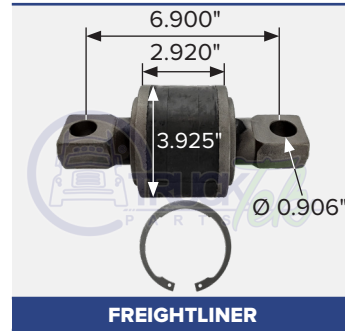

**FREIGHTLINER**  
OEM 800480078  
Torque V-Rod apex bushing kit (with snap ring)

**TTH6195**

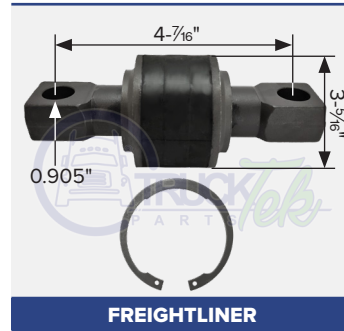

**FREIGHTLINER**  
OEM 70480054000  
Torque V-Rod apex bushing kit (with snap ring)

**TTH6716**



**FREIGHTLINER**  
OEM 6813266716, 13045, 81897  
Torque rod bushing FAS II

**TTH3962**



**FREIGHTLINER**  
OEM 1613962000  
Bushing Fas II

**PHM-7-HUS6620**

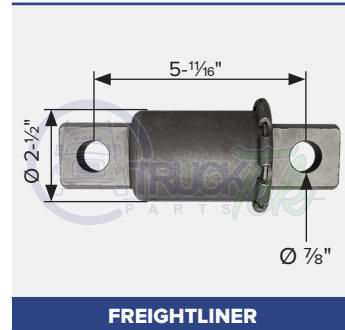

**FREIGHTLINER**  
OEM 1616412000  
Anti-walk pivot bushing

**TTH7770**



**FREIGHTLINER**  
OEM 1617770000, 1614603000  
Silent block bushing

**TTH0934**



**FREIGHTLINER**  
OEM 60432002  
Silent block bushing

**TTHRB135**



**FREIGHTLINER**  
OEM 1616347000  
Silent block bushing RB135

**TTH0211**



**FREIGHTLINER**  
OEM 6803220150  
Silent block bushing RB211

**TTH2181**



**FREIGHTLINER**  
Front suspension spring eye bushing

**TTH2182**



**FREIGHTLINER**  
OEM 16-20508-000  
Front suspension spring eye bushing



## TTH1697

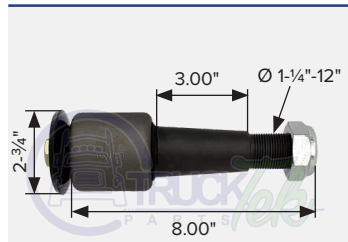

**HENDRICKSON**

OEM 44697-000, 226910  
Torque rod conical bushing

## TTH59217



**HENDRICKSON**

OEM 64697  
Torque rod conical bushing

## TTH64404

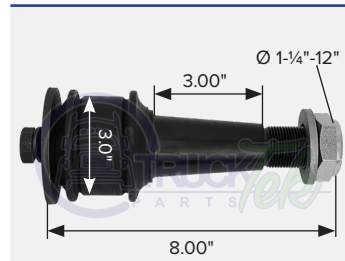

**HENDRICKSON**

OEM 64400004  
Conical torque arm bushing

## TTH6440

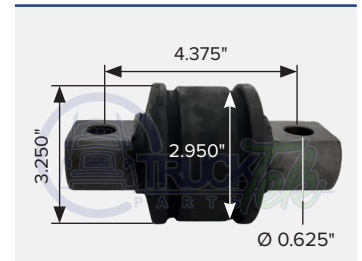

**HENDRICKSON**

OEM 64400005  
Torque arm bushing

## TTH44694

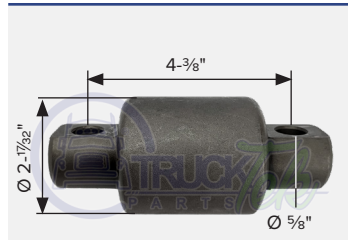

**HENDRICKSON**

OEM 44694-000  
Torque rod bushing

## TTH44695



**HENDRICKSON**

OEM 44695-000  
Torque rod bushing

## TTH57256

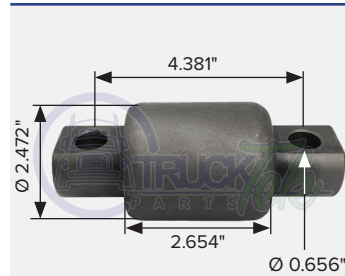

**HENDRICKSON**

OEM 57256  
Torque rod bushing

## TTH447691C

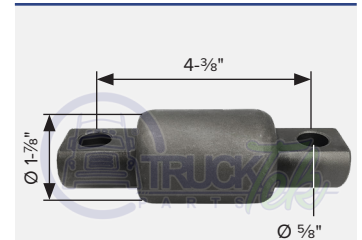

**HENDRICKSON**

OEM 47691  
Torque rod bushing, differs from TTH17691 by the metal outer

## TTH3000

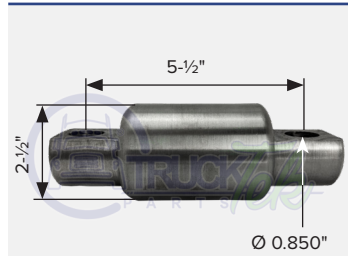

**HENDRICKSON**

OEM 60383000  
Torque rod D-Pin bushing

## TTH3001

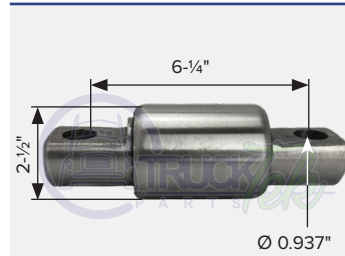

**HENDRICKSON**

OEM 1629614, 3198122, 1076510  
Torque rod D-Pin bushing

## TTH0014



**HENDRICKSON**

OEM B038590  
V-Rod end bushing

## TTH17691



**HENDRICKSON**

OEM 47691-000, E5275  
T-rod bushing

## TTH1387

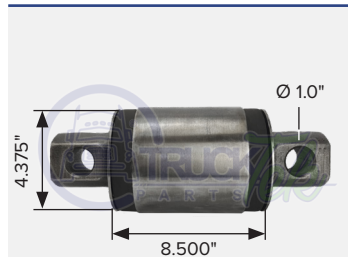

**HENDRICKSON**

OEM 34013088  
Side Bar-pin

## TTH1387

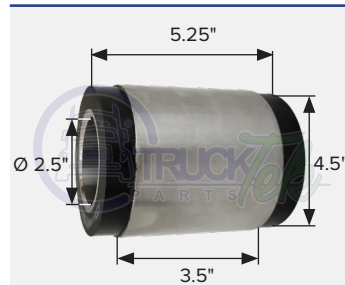

**HENDRICKSON**

OEM 06969000  
Side bushing for 44,000 lbs trailer

## TTH1972

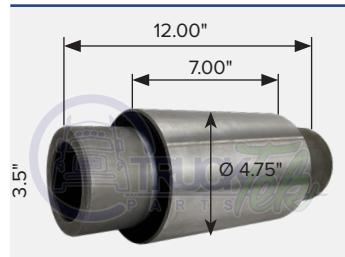

**HENDRICKSON**

OEM 49400000  
Center bushing for 44,000 lbs trailer

**TTH44000**



x2 TTH1972      x4 TTH0459      x4 PHM 2026

**HENDRICKSON**

Bushing kit with adapters for 44,000 lbs equalizing beam

**TT7420**



**HENDRICKSON**

OEM 47420000  
Center equalizer bushing PHM 15014 (Poliurethane)

**TT7421**



**HENDRICKSON**

OEM 47421000, C136002  
Side equalizer bushing PHM 15014

**TTH3003**

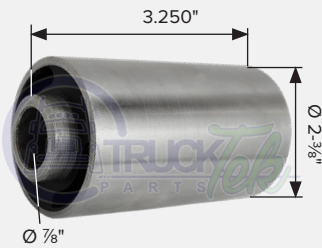

**HENDRICKSON**

OEM 60443000, RB300  
Leaf spring bushing

**TTH4502**



**HENDRICKSON**

OEM 800480078  
Leaf spring bushing

**TTHR233**

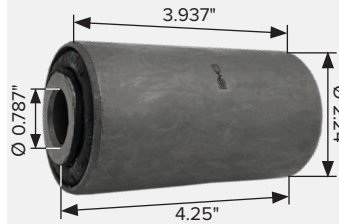

**HENDRICKSON**

OEM 70480054000  
Leaf spring bushing

**TTH4501**

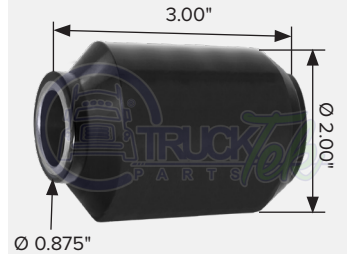

**HENDRICKSON**

OEM 47692000  
Leaf spring bushing

**TTH5031**

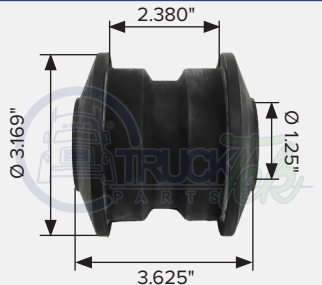

**HENDRICKSON**

OEM 58648000  
Pivot bushing

**TTH1460**

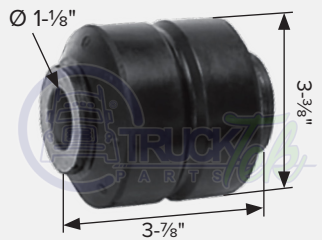

**HUTCH**

OEM 1614601, 1872301, 2072901  
Equalizer bushing, 1-1/8" pin

**TTH1461**



**HUTCH**

OEM 1614601, 1872301, 2072901  
Equalizer bushing, 1" pin

**TTH1123**



**HUTCH**

Torque rod bushing

**TTH10123**



**HUTCH**

OEM 39400016, 90008243,  
D0HZ5781B  
Tensioner bushing

**TTH1472**



**HUTCH**

OEM 7010-00, UCA0472  
Two holes equalizer bushing

## TTH7501



**INTERNATIONAL**  
OEM 497501C2  
Equalizer beam bushing

## TT734511



**INTERNATIONAL**  
OEM 3525665C1, 4C4Z5348BA  
Spring eye bushing

## PHM-3-1535



**INTERNATIONAL**  
OEM 501535C2  
Hanger roller

## TTH0006



**KENWORTH**  
Spring bushing

## TTHRB249

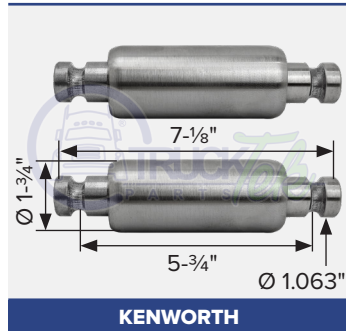

**KENWORTH**  
OEM 50275  
2 spring eye hanger bushing for T2000, RB249

## TTHRB295

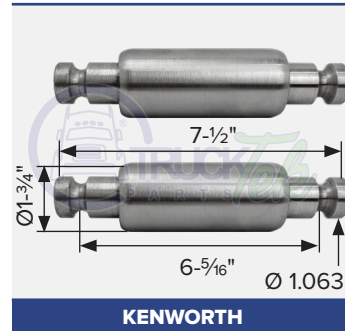

**KENWORTH**  
OEM B651006, 52256, 52272  
Spring eye hanger bushing 59-502, 59-504, 59-506, 59-518

## TTHRB328

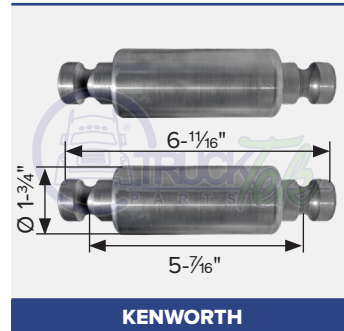

**KENWORTH**  
OEM 52375, B656005  
2 spring eye hanger bushing

## TTHRB308

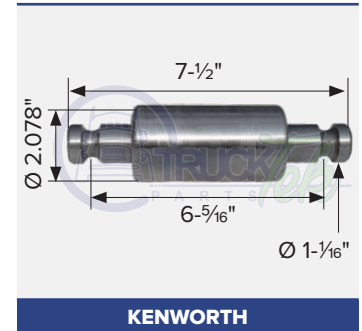

**KENWORTH**  
OEM B651012, RB308, RB323  
Spring eye hanger bushing

## TTPRB324



**KENWORTH**  
OEM B656006, 52411, B651013, 52758  
Shackle pin kit for T-600, T-800

## TTH9069

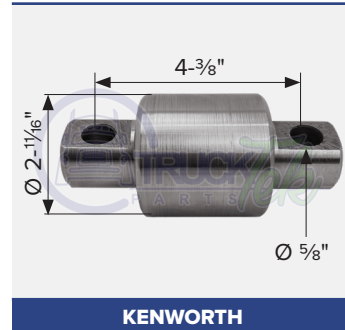

**KENWORTH**  
OEM K066-342  
Torque rod bushing

## TTH836940

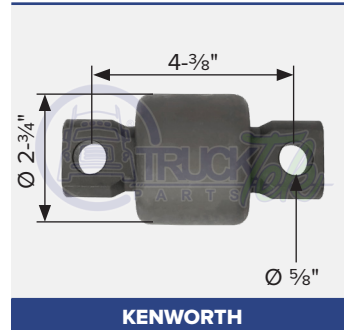

**KENWORTH**  
OEM 60314000  
Torque rod and stabilizer bar bushing for airglide

## TTH8496



**KENWORTH**  
OEM C131005  
Sway bar bushing for Airglide 400

## TTH21007



**KENWORTH**  
OEM C131007  
Sway bar bushing kit for Airglide, 4 bushings TTH8496, 4 bolts 5/8" x 12"

## TTH941328



**MAN**  
OEM 81437220068, 81437220069, 81437220080  
Stabilizer bar bushing



**TTH3594**



**MERCEDES BENZ**

OEM 1435944

Torque bushing, Scania

**TTH4405**

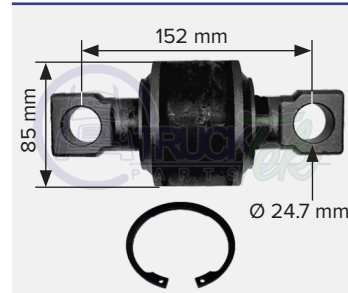

**MERCEDES BENZ**

OEM A0003504405

Tie bar bushing

**TTH0050**

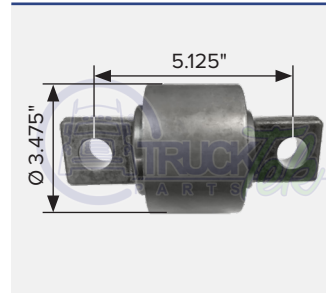

**MERCEDES BENZ**

OEM A9423260050

Stabilizer bushing

**TTH941326**



**MERCEDES BENZ**

OEM 9413260050

Stabilizer bushing

**TTH941327**



**MERCEDES BENZ**

OEM 974 327 0281

Stabilizer bushing

**TTH0181**

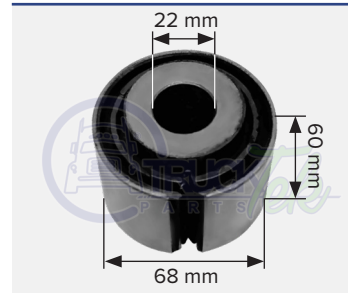

**MERCEDES BENZ**

OEM A9743270181

Stabilizer bushing

**TTH9266**



**MERCEDES BENZ**

OEM 634 326 0081

Stabilizer bar bushing kit

**TTH9332**

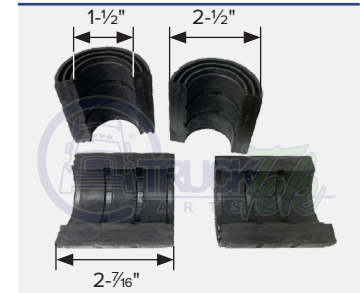

**MERCEDES BENZ**

OEM 634 223 7081

Stabilizer bar bushing kit

**TTH0017**

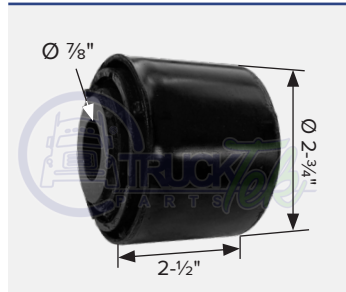

**MERITOR**

OEM 1471301

Torque rod bushing

**TTH7380**

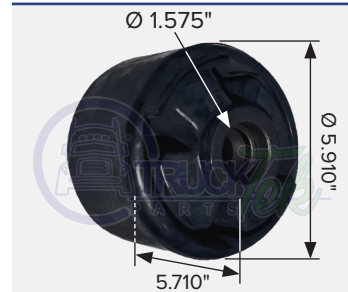

**MERITOR**

OEM 21227380, 21230539, A1225C1537

Pivot bushing, wide

**TTH0476**

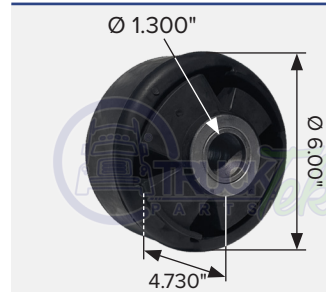

**MERITOR**

OEM 21230476, 21226997, A1225N1522

Pivot bushing, short

**TTP0016**

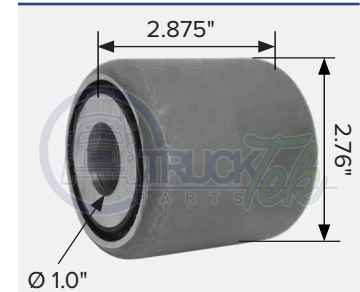

**NEWAY**

OEM 90008264

Apex bushing

**TTH21591**



**NEWAY**

OEM S21591, C21591, 90008006, 4KP971

Beam end bushing ARD 5.250 wide HANGER

**TT8139**



**NEWAY**

OEM 90008139, 90008102, 10050 Beam end bushing AR-41, 70, 75M, 90, 95, ART500B, 500-7S-A

**TT8148**

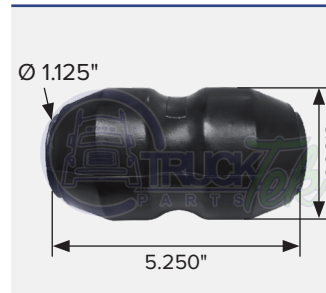

**NEWAY**

OEM 90008148, 90008149, 11223 Beam end bushing AR90, 92, 93, 250, NS, ER & RC, RL, RLU SERIES

**TTH8113**



**NEWAY**

OEM 90008113, 350330066 Transverse beam bushing



# POLÍTICA DE CALIDAD

EN PHM INNOVAMOS



FABRICAMOS



Y COMERCIALIZAMOS PARTES



ENFOCADOS EN SATISFACER  
NECESIDADES Y REQUISITOS



QUE APLICAN A LA INDUSTRIA  
DEL TRANSPORTE DE CARGA



CON PERSONAL COMPROMETIDO  
Y COMPETENTE



PARA BRINDAR VARIEDAD  
SEGURIDAD Y CONFIABILIDAD



TRABAJANDO EN MEJORAR CADA DÍA NUESTROS PROCESOS.



**TTH1902**



**REYCO**  
OEM 064902  
Equalizer bushing 1" pin

**TT4713**



**REYCO**  
OEM 1471301  
Equalizer bushing for 101, 101A, 102, 102W/201

**TTH3294**



**VOLVO**  
OEM 20533294  
Silent spring bushing

**TTH4000866**



**VOLVO**  
"V" rod bushing

**TTH1187**



**VOLVO**  
"V" rod bushing

**TT638862**



**VOLVO**  
OEM 638862  
"V" rod bushing for Scania/Volvo

**TTH2078086**



**VOLVO**  
OEM 20740700  
Stabilizer bar bushing

**TTH13558**



OEM C3558  
Tri-functional bushing for wide-beam systems

**TTH1364**



OEM: D25364, D22845  
Tri-functional bushing for narrow-beam systems

**TTH13558KIT**



OEM: A6914, S6914, 002202  
Wide tri-functional bushing, 1-1/8" bolt and wear pads washers kit

**TTHQ13558KIT**



OEM S24681, S24112, 002963  
Wide tri-functional bushing, 1-1/8" quick alignment bolt and wear pads washers kit

**TTHQA13558KIT**



OEM: 004588  
Wide tri-functional bushing, collars, 1-1/8" quick alignment bolt and wear pads washers kit

**TTHQA1364**



OEM: 004588  
Narrow tri-functional bushings, 1-1/8" quick alignment bolts and wear pads washers, two pieces each kit

## TT46773



**FREIGHTLINER**

OEM A1615773000

Lower spring pad, front suspension M2

## TTH1615

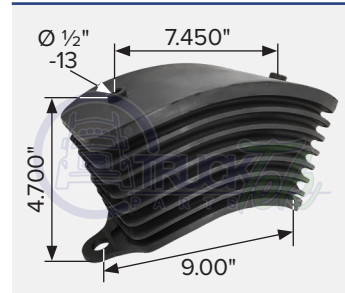

**FREIGHTLINER**

OEM 1615010000, 1614508000, 1614508001

Bolster spring

## PHM-7-TOPES07



**FORD**

Spring stop

## TTH7001

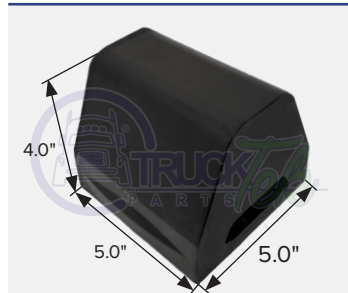

**HENDRICKSON**

OEM 38947000

Auxiliary spring

## TTH9377

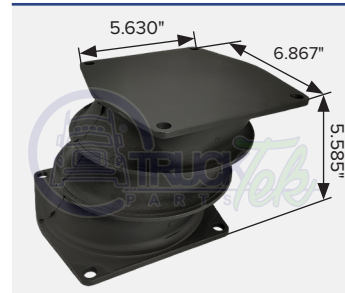

**HENDRICKSON**

OEM 49377 64718000L

Spring bolster

## TTH9037

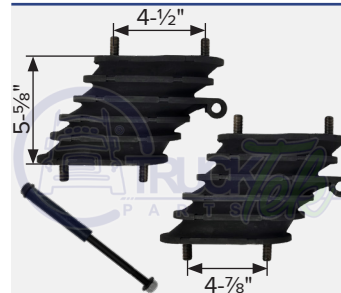

**HENDRICKSON**

OEM 64179-037

Tie-bar bolster spring kit

## TT758918

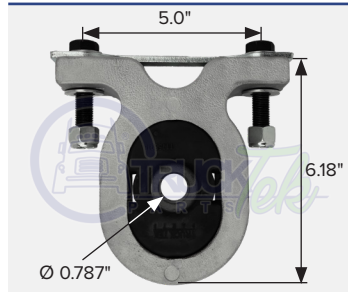

**INTERNATIONAL**

Spring mount support kit

## TTH0002



**INTERNATIONAL**

Rebound stop

## PHM 25356



**INTERNATIONAL**

OEM 3563165C91

Auxiliary spring

## TT14670

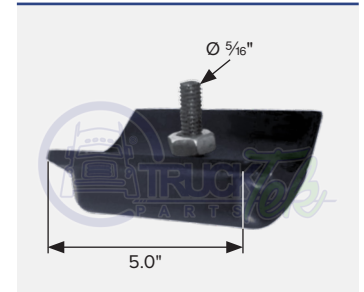

**ISUZU**

OEM 8-94119-958-1

Spring bumper

## TTHK365



**MACK**

Spring cushion

## TTH9194



**MACK**

Spring cushion

## TTH9195



**MACK**

Spring cushion



# DOWNLOAD OUR CATALOGS



## HENDRICKSON

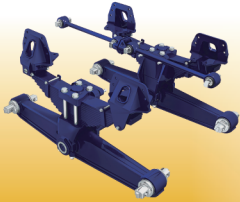

DOWNLOAD ME

## KENWORTH



DOWNLOAD ME

## INTERNATIONAL



DOWNLOAD ME

## FREIGHTLINER



DOWNLOAD ME

## PETERBILT



DOWNLOAD ME

## POLIURETANO



DOWNLOAD ME

## HULE CATÁLOGO



DOWNLOAD ME



TECNOLOGÍA DE VANGUARDIA

## TTHFW036KIT



**FONTAINE**

OEM BSH108U, BSH109L  
 Buje para quinta rueda tipo 6000, 7000, 7000c

## TTHFW009



**FONTAINE**

OEM BSH150  
 Buje de quinta rueda tipo ASYAWS, ASYAWB, ASIAWX series

## TTHFW001



**HOLLAND**

OEM XB00112  
 Buje de quinta rueda

## TTH9279



**HOLLAND**

OEM XB10605  
 Buje para quinta rueda tipo Holland

## TTH0594



**JOST**

OEM SK290594, SK290595  
 Buje para quinta rueda tipo Jost  
 JSK37U, JSK37UA, JSK37US

---

## AMENDMENT

The manufacturers names and reference numbers in this catalog are only for assistance in product identification and it is not assumed that the products are from those manufacturers.

The dimensions of the product are the commercial ones and may vary slightly from the real ones.

Although special care has been taken with the veracity of the data in this catalog, TRUCKTEK® does not assume any responsibility for errors or omissions.



## CONTACT US

 (+52) 33 3145 1011

 (+52) 33 3145 1884

 (+52) 33 3145 1876

 (+52) 33 1254 7813

 (+52) 33 1461 0175

 (+52) 33 2184 3148

 (+52) 33 2615 1393

 (+52) 33 1263 5401

 [ventas@phm.com.mx](mailto:ventas@phm.com.mx)

 [contacto@phm.com.mx](mailto:contacto@phm.com.mx)

 <http://phm.com.mx>

