

# PRODUCTOS NUEVOS

*NOVIEMBRE 2023*



TECNOLOGÍA DE VANGUARDIA

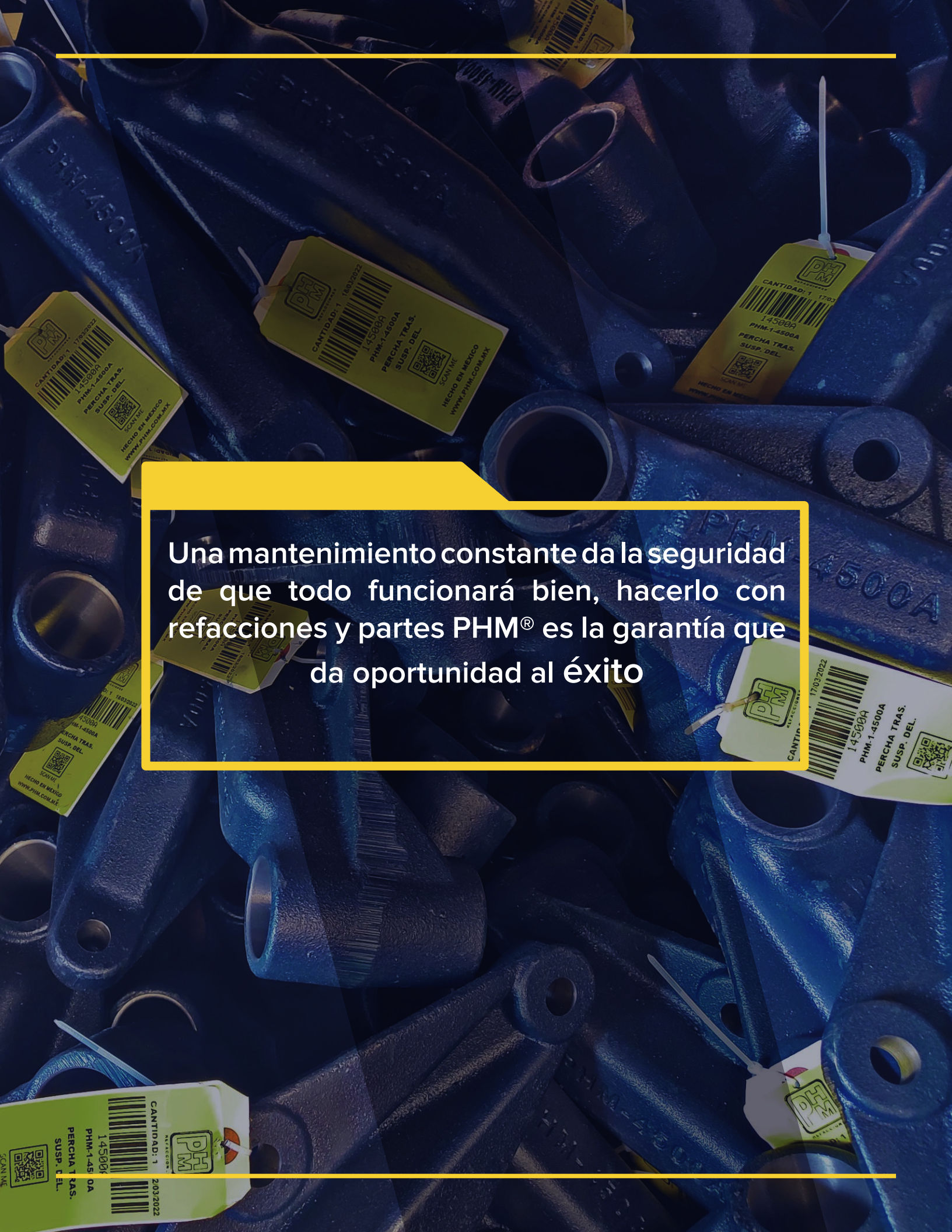

The background of the image is a dense collection of blue-painted metal suspension components, likely for a vehicle. Each component has a yellow tag attached to it. The tags feature the PHM logo, a barcode, and text including 'CANTIDAD: 1', '17/03/2022', '14500A', 'PHM-1-4500A', 'PERCHA TRAS. SUSP. DEL.', 'SCAN ME', 'HECHO EN MEXICO', and 'WWW.PHM.COM.MX'. The components are arranged in a way that shows various angles and details of the parts.

Una mantenimiento constante da la seguridad de que todo funcionará bien, hacerlo con refacciones y partes PHM® es la garantía que da oportunidad al éxito

## Donde todo comenzó

PHM® surge en los 80's a través del desarrollo de las habilidades de servicio de los socios fundadores que tuvieron la oportunidad de elaborar partes en un mercado con escasez de refacciones para tracto-camiones.

PHM® es fundada en junio de 1979 como una pequeña compañía que poco a poco tomó una gran presencia en la industria expandiendo su alcance hasta el extranjero.

Te presentamos el catálogo de Hendrickson 2022 en el que te contamos un poco de lo que es PHM® y de lo que hacemos aquí.



## NUESTRA MISIÓN

Fabricar y proveer refacciones y partes para equipo de transporte, agrícola e industrial, desarrollando el valor de nuestra marca mediante la innovación y servicio, orientados a la satisfacción de nuestros clientes, colaboradores, accionistas y consumidores.

Satisfacer las necesidades de los clientes en forma oportuna y eficaz, con el producto adecuado y a un precio competitivo, a través de la mejora continua de nuestro sistema de gestión de calidad

Generar valor y mejoramiento de la comunidad y región a través del servicio que proveemos, anteponiendo nuestro compromiso con el medio ambiente

## NUESTRA VISIÓN

Posicionar nuestra marca a nivel mundial, utilizando procesos flexibles altamente productivos, desarrollados por colaboradores calificados, duplicando nuestro valor a corto plazo, seguir consolidando una organización comprometida con la sociedad y el medio ambiente.

Ser reconocidos como la mejor opción por la durabilidad y fiabilidad de nuestros productos y por la labor de proveer el mejor servicio para la completa satisfacción de nuestros clientes y consumidores

# CONTENIDO

	Página
Nosotros	3
Misión y visión	4
Filosofía	6
<b>PRODUCTOS</b>	
Cabina	7
Cofre	10
Motor	13
Mangueras	14
Tanques	17
Tensores de radiador	17
Tapones	18
Frenos	19
Dirección	21
Quinta rueda	24
Suspensión	25
Chasis	33
Pernos	35
Balancines	36
Bujes	37
Rondanas	38
Transmisión	39
Varios	40
<b>TRUCKTEK</b>	42
<b>Garantía y rectificación</b>	43

# FILOSOFÍA DE PHM®

## **Cada integrante de PHM®**

Se cultiva el respeto a la dignidad de cada persona y a la manifestación de sus ideas, es requisito esencial en la calidad de nuestras relaciones interpersonales dentro y fuera del trabajo.

## **Confianza**

La integridad de nuestro actuar como personas debe ser un ejemplo cotidiano para quienes nos rodean y un factor que nos ayude a obtener en todo momento la cooperación libre y entusiasta de todos ellos.

## **La perseverancia**

Como actitud ante la vida ha sido nuestra característica a lo largo de los años y nos ha permitido, juntos, como si fuéramos uno solo, enfrentar y sortear exitosamente etapas difíciles.

## **Dignidad humana**

Creemos en la esencia humana que nos da el valor para aceptar nuestros errores e insuficiencias, llanamente sin paliativos, con la verdad, sabiendo cuando es necesario pedir ayuda, pero también para reconocer sin cortapisa ni regateo, los logros ajenos.

## **Valores**

El amor que recibimos de nuestros padres y que vivimos entre nosotros, es el momento que nos une, cohesiona y fortalece, lo que nos hace vivir con alegría estos valores, aceptar los retos y disfrutar los momentos que compartimos juntos. Por ello, nos empeñamos en acrecentarlo para convertirlo en norma de vida permanente que nos impulse a mejorar nuestra misión como individuos, hermanos y empresarios.

**PHM-1-7060**



**KENWORTH**

OEM K235-1818

Soporte de cabina

**PHM-3-0015**

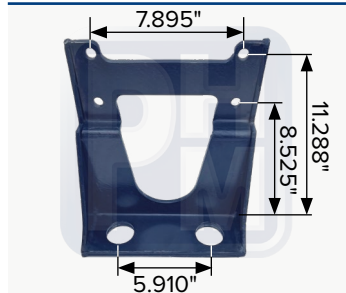

**KENWORTH**

OEM K235-1436

Soporte trasero de cabina

**PHM-7-5682**



**FREIGHTLINER**

OEM 15-1568

Soporte de cabina tipo columbia, Cascadia

**PHM-7-1S196**



**MACK**

OEM 6222084-001, 1201542-01, 1S4-196, 1204937-001

Bolsa de aire de asiento

**PHM-7-FI7215**



**FREIGHTLINER**

OEM

Bolsa de aire para cabina modelo 2009

**Z48100225**



**HENDRICKSON**

OEM R307852, HPB4503, E7852

Varilla niveladora

**Z48100267**

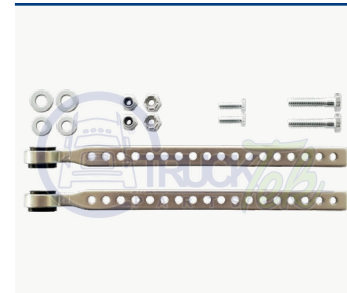

**HENDRICKSON**

OEM

Juego varilla 13-1/2"

**Z48100367**



**HENDRICKSON**

OEM

Juego varilla 14"

**TTH6499**



OEM

Goma para pedal clutch y freno tipo

**TC0001**



OEM

Cartel señalización

**TTHK17432**



**FREIGHTLINER**

OEM 1868767000

Soporte de cabina

**PHM-1-9120**

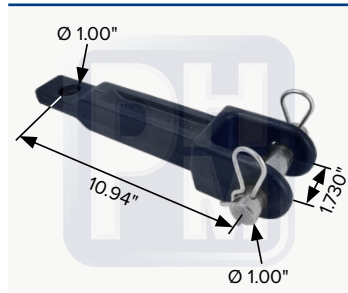

OEM

Gancho largo para tirón delantero

**PHM-1-9121**

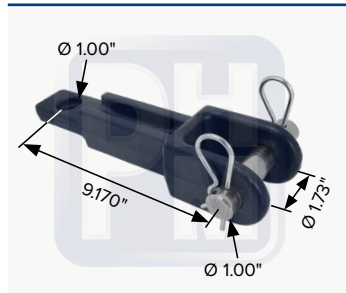

OEM

Gancho corto para tirón delantero

**TTH6818**



**FREIGHTLINER**

OEM 1843637000, 1843636000, 6818910001, 811320, 2218570

Soporte de cabina

**TTP20306**



**PETERBILT**

OEM D29691107, 2008257

Soporte de cabina

**TC2141**



**FREIGHTLINER**

OEM

Jaladera interior izquierda

**TC2142**



**FREIGHTLINER**

OEM

Jaladera interior derecha

**TC2595**



**FREIGHTLINER**

OEM

Jaladera interior izquierda

**TC2596**



**FREIGHTLINER**

OEM

Jaladera interior derecha

**TC1067**



**FREIGHTLINER**

OEM

Jaladera exterior izquierda

**TC1068**



**FREIGHTLINER**

OEM

Jaladera exterior derecha

**TC1067C**



**FREIGHTLINER**

OEM

Jaladera exterior cromada derecha

**TC1068C**



**FREIGHTLINER**

OEM

Jaladera exterior cromada derecha

**TC1055**



**FREIGHTLINER**

OEM

Jaladera exterior izquierda

**TC1059**

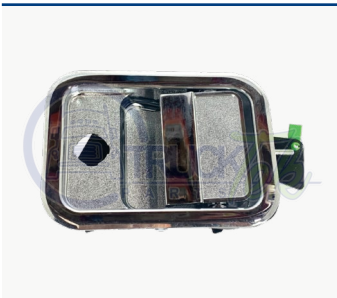

**FREIGHTLINER**

OEM

Jaladera exterior derecha

**TC1088**



**FREIGHTLINER**

OEM

Cerradura derecha

**TC2029**



**FREIGHTLINER**

OEM

Cerradura interior izquierda

**TC2039**

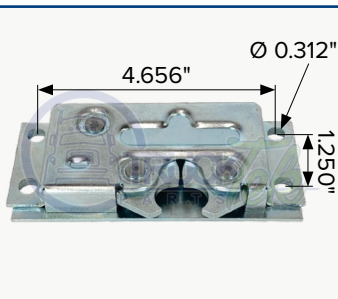

**INTERNATIONAL**

OEM 1677432C1

Cerradura interior izquierda

**TC2040**

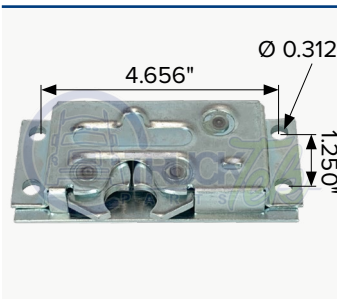

**INTERNATIONAL**

OEM 1677433C1

Cerradura interior derecha

**TC2073**



**INTERNATIONAL**

OEM

Jaladera Interior negra

**TC2074**



**INTERNATIONAL**

OEM

Jaladera Interior negra



**TC2073HDR**

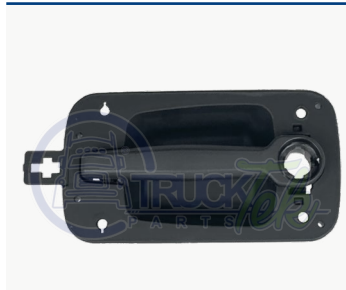

**INTERNATIONAL**

OEM

Jaladera derecha exterior negra

**TC1073HDL**



**INTERNATIONAL**

OEM

Jaladera izquierda exterior negra

**TC2075**



**INTERNATIONAL**

OEM

Jaladera Interior cromada para

**TC2076**



**INTERNATIONAL**

OEM

Jaladera Interior cromada para

**TC1073HDRC**



**INTERNATIONAL**

OEM

Jaladera derecha exterior cromada

**TC1073HDLC**



**INTERNATIONAL**

OEM

Jaladera izquierda exterior cromada

**TC2165**



**KENWORTH**

OEM

Chapa exterior izquierda para kenworth

**TC2166**



**KENWORTH**

OEM

Chapa exterior derecha para kenworth

**TC2257**



**KENWORTH**

OEM

Jaladera interior izquierda

**TC2258**



**KENWORTH**

OEM

Jaladera interior derecha

**TC2461**



**KENWORTH**

OEM

Jaladera interior izquierda

**TC2462**



**KENWORTH**

OEM

Jaladera interior derecha

**TC1078**



**KENWORTH**

OEM R56-1025R

Chapa exterior derecha

**TC2191**



**VOLVO**

OEM 20745996

Jaladera izquierda

**TC2192**

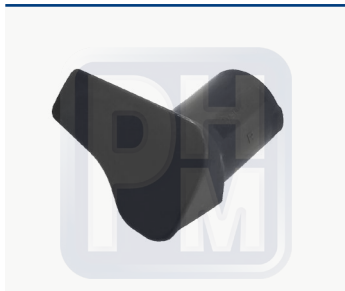

**VOLVO**

OEM 20745997

Jaladera derecha

**TC2271**

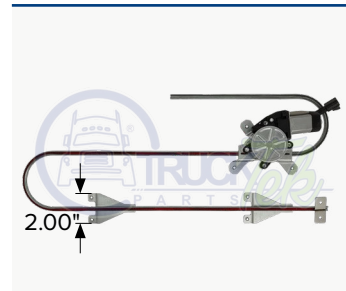

**KENWORTH**

OEM R21-1005

Elevador para ventana izquierdo

**TTH1048**



**FREIGHTLINER**

OEM A1715370000

Cierre izquierdo de cofre tipo Cascadia

**TTH1049**



**FREIGHTLINER**

OEM A1715370001

Cierre derecho de cofre tipo Cascadia

**TTH9028**

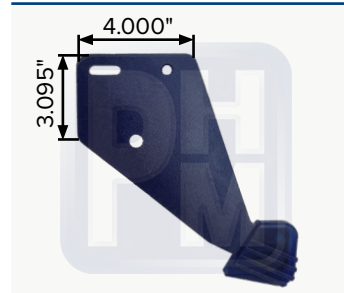

**INTERNATIONAL**

OEM 4044825C1, 3577047C1, 3577047C2

Guía de cofre

**PHM-7-9029**

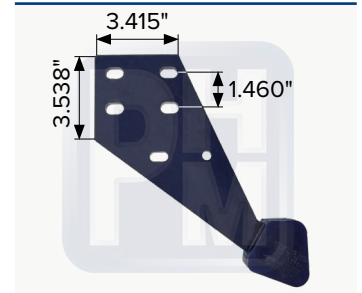

**INTERNATIONAL**

Guía derecha para cofre

**TTH5342**



**FREIGHTLINER**

OEM 17-14706-000

Guía de cofre tipo Century

**PHM-7-1237**

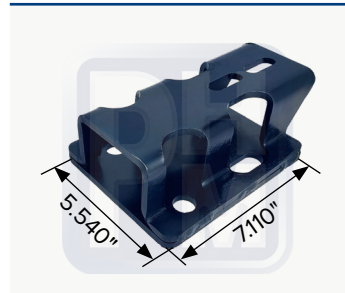

**KENWORTH**

OEM BS-KA10

Base de bisagra para cofre tipo Kenworth T660

**TTH0027L**

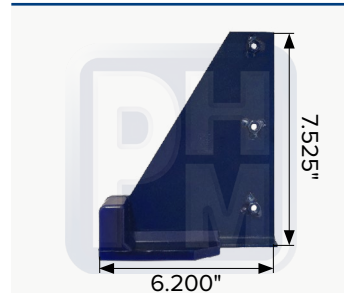

**KENWORTH**

OEM L82-1105

Soporte de cofre izquierdo

**TTH0027R**

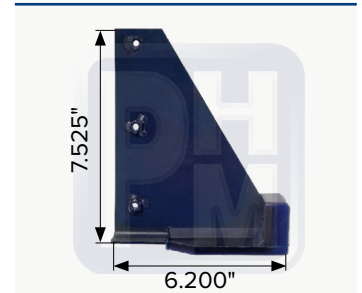

**KENWORTH**

OEM L85-00105R

Soporte de cofre derecho

**PHM-7-1236L**



**KENWORTH**

OEM K22495

Bisagra para cofre izquierda

**PHM-7-1236R**



**KENWORTH**

OEM K22435

Bisagra para cofre derecha

**PHM-7-1516LH**



**KENWORTH**

Soporte para base de cofre izquierdo

**PHM-7-1516RH**



**KENWORTH**

Soporte para base de cofre derecho

**PHM-7-8817L**



**KENWORTH**

OEM A85-1242

Soporte izquierdo de bisagra para cofre tipo Kenworth

**PHM-7-8817R**



**KENWORTH**

OEM A85-1242R

Soporte derecho de bisagra para cofre tipo Kenworth

**PHM-7-0408R**



**KENWORTH**

Soporte parachoques derecho

**PHM-7-0408L**



**KENWORTH**

Soporte parachoques izquierdo

**PHM-7-2108**



**KENWORTH**

Guía de cofre

**PHM-7-8842**



**KENWORTH**

Soporte de faro

**PHM-7-0047**



**KENWORTH**

Soporte de defensa tipo Kenworth

**PHM-7-1518**



**KENWORTH**

OEM A85-1229  
Soporte de defensa inferior

**PHM-7-3787R**



**FREIGHTLINER**

OEM A17-13787-002  
Guía de cofre derecha

**PHM-7-3787L**



**FREIGHTLINER**

OEM A17-13787-002  
Guía de cofre izquierda

**PHM-7-4713**



**KENWORTH**

Soporte de pivote para bisagra tipo Kenworth

**PHM-7-0028**



**KENWORTH**

Guía hembra para cofre

**PHM-7-1353L**



**KENWORTH**

OEM N11-1353  
Base soporte de defensa izquierda Kenworth T660

**PHM-7-1353R**



**KENWORTH**

OEM N11-1353R  
Base soporte de defensa derecha Kenworth T660

**PHM-7-6232L**



**KENWORTH**

OEM L11-6232  
Soporte de chicote de cofre izquierdo

**PHM-7-6232R**



**KENWORTH**

OEM L11-6232  
Soporte de chicote de cofre derecho

**PHM-7-2078L**

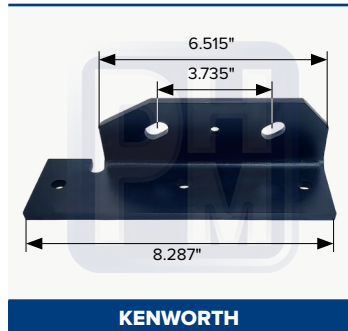

**KENWORTH**

OEM N11-1201  
Soporte para cofre izquierdo

**PHM-7-2078R**

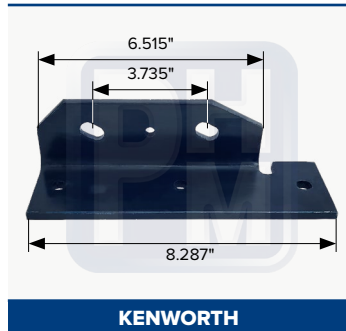

**KENWORTH**

OEM N11-1201  
Soporte para cofre derecho

**PHM-7-8807**



**INTERNATIONAL**

OEM 3506126C1  
Soporte tipo NaviStar

**PHM-7-212730**



**FREIGHTLINER**

OEM 564.46302  
Receptáculo de parachoques

**PHM-7-6696**

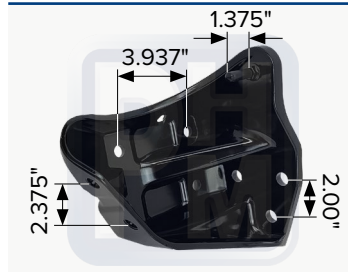

**FREIGHTLINER**

OEM A2128565001

Soporte derecho de defensa para Cascadia

**PHM-7-6697**

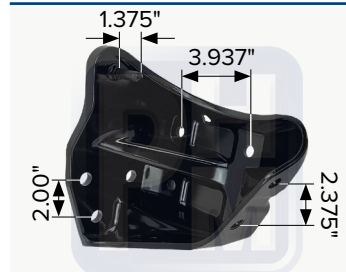

**FREIGHTLINER**

OEM A2128565000

Soporte izquierdo de defensa para Cascadia

**PHM-7-6463**



**FREIGHTLINER**

OEM 17-15346-003

Soporte derecho de cofre para Cascadia

**PHM-7-6462**



**FREIGHTLINER**

OEM 17-15346-002

Soporte izquierdo de cofre para Cascadia

**TTH2061**



**VOLVO**

OEM 20498998, 20878648,

Gancho para cofre superior tipo Volvo

**TTH2070**



**VOLVO**

OEM 2048998, 8081359,

Gancho para cofre superior tipo Volvo

**TTH1062**

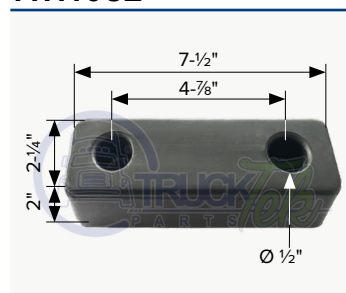

Tope defensa

**TTH1063**

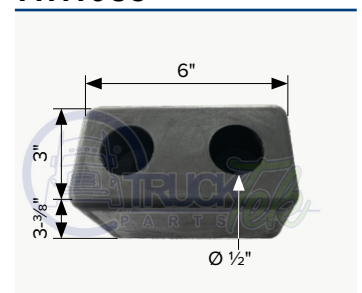

Tope defensa

**TTH171800**



**KENWORTH**

OEM L566027

Gancho para cofre tipo T2012 en adelante

**TTH171801**



**KENWORTH**

OEM L561037

Gancho para cofre tipo T700

**TC2031**



**VOLVO**

Cierre de cofre

**TC2032**



**VOLVO**

Cierre de cofre

**TTH6132A**



**CHEVROLET**

OEM

Base para gancho tipo Chevrolet

**TTH6133**



**MERCEDES BENZ**

OEM

Gancho para cofre tipo Mercedes Benz

**TTH6149**

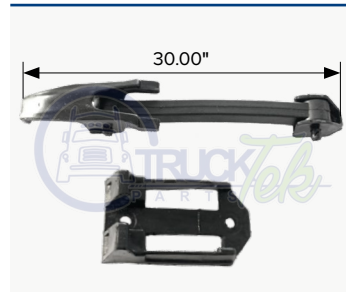

**CHEVROLET**

OEM

Gancho para cofre

**TTH1022L**



**INTERNATIONAL**

OEM 3544925C1

Gancho para cofre tipo ProStar

**PHM-7-1086R**



**KENWORTH**

OEM N711086R

Soporte de defensa derecho

**PHM-7-1086**



**KENWORTH**

OEM N711086

Soporte de defensa izquierdo

**TTH6117**

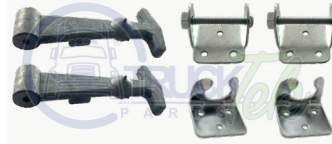

OEM

Juego de ganchos para cofre

**TTH6111**



**INTERNATIONAL**

Herraje para gancho tipo Dina

**TTH6114B**

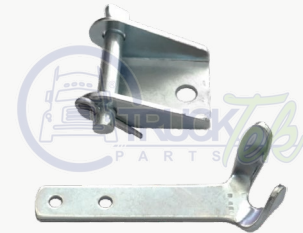

**KENWORTH**

Base para gancho

**TTP2443**



**FREIGHTLINER**

OEM A17-17256-000

Aislador de parrilla delantera tipo Cascadia

**PHM-3-8236**

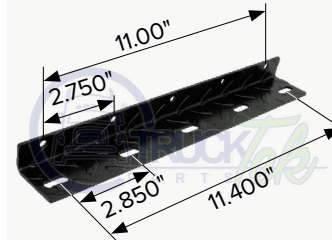

**KENWORTH**

OEM K078-236

Ángulo soporte de tope de cofre para T370

**TC3533**

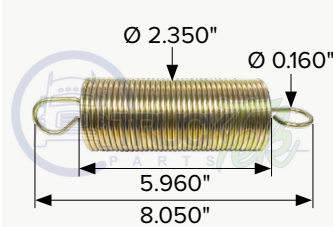

**INTERNATIONAL**

OEM

Resorte para cofre tipo International 940025 / 2600, 5000 81 / 82 / 8300, 91 / 92 / 9400

**TC3535**

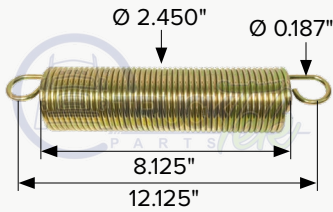

**INTERNATIONAL**

OEM 3530122C1

Resorte para cofre tipo International 9200, 9900

**TC7100**

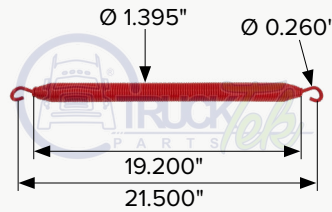

**KENWORTH**

OEM K224-81

Resorte para cofre T600 / 800 / W900 mod '98 - '06

**TC7102**



**KENWORTH**

OEM L711002

Resorte para cofre W900I mod '99 - '11

**TC7104**



**KENWORTH**

OEM L711004

Resorte para cofre

**TC7105**



**KENWORTH**

OEM K22495

Resorte para cofre T400 / 450 / 800 mod '98 - '03

**TC7106**

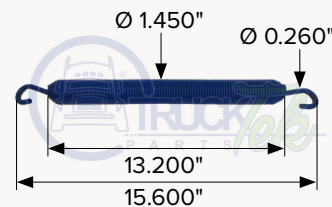

**KENWORTH**

OEM K22495

Resorte para cofre

**TC7107**

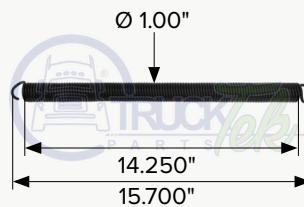

**KENWORTH**

OEM K22435

Resorte para cofre c500b / t800 / w900b mod '98 - '06

**TC1709**

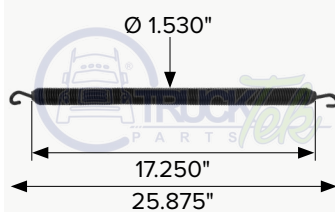

**FREIGHTLINER**

OEM 1712609000

Resorte para cofre tipo Freightliner FL60 / 70 / 80

# VALORES



## INNOVACIÓN

Aplicamos nuevas ideas continuamente buscando mejorar continuamente nuestra empresa, nuestros procesos y productos.



## SERVICIO

Tenemos la actitud para servir y ser de utilidad y beneficio a las necesidades de nuestros clientes tanto como externos como internos.



## PRODUCTIVIDAD

Nos capacitamos constantemente para lograr nuestros objetivos y lograr que los procesos y productos sean eficientes y sin pérdida.



## COMPROMISO

Nuestro deber de cumplir con los compromisos y convenios adquiridos y de hacer lo necesario para cumplir las metas y objetivos de nuestra organización.



## PERSEVERANCIA

A través del aprendizaje y la experiencia adquirimos la habilidad, la tenacidad y el empeño para eludir situaciones adversas para encontrarnos con el éxito



## RESPECTO

El respeto es el valor principal de PHM®, ponemos por encima de todo la dignidad de las personas y alentamos la manifestación de sus ideas, el respeto es la norma para llevar nuestras relaciones con calidad humana.

# POLÍTICA DE CALIDAD

EN PHM INNOVAMOS



FABRICAMOS



Y COMERCIALIZAMOS PARTES



ENFOCADOS EN SATISFACER  
NECESIDADES Y REQUISITOS

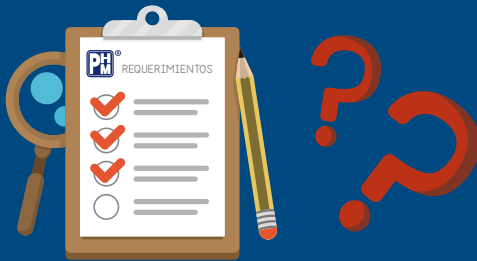

QUE APLICAN A LA INDUSTRIA  
DEL TRANSPORTE DE CARGA



CON PERSONAL COMPROMETIDO  
Y COMPETENTE



PARA BRINDAR VARIEDAD  
SEGURIDAD Y CONFIABILIDAD



TRABAJANDO EN MEJORAR CADA DÍA NUESTROS PROCESOS.



**PHM-6-0050**



Rotula tornillo de 1/2 buje de nylon

**PHM-6-0051**



Rotula hueca 7/16 buje de nylon

**2124500**



Rotula hueca 8 mm DIN 648-8

**2124501**



Rotula hueca 10 mm DIN 648-10

**2124502**



Rotula hueca 12 mm DIN 648-12

**2124998**



Rotula hueca 1/4 buje de nylon

**2125000**



Rotula hueca 8 mm buje de nylon

**2125001**



Rotula hueca 7/16 buje de nylon

**2125002**



Rotula hueca 3/16 buje metal cuerda

**2125003**



Rotula hueca 1/2 buje de nylon

**2125007**



Rotula hueca 1/4 buje de nylon

**2125008**



Rotula hueca 5/16 buje de nylon

**2125012**



Rotula tornillo 3/8

**2125013**



Rotula hueca 3/16 buje de nylon

**2125062**



Rotula tornillo 5/8 buje de nylon

**2140055**



Rotula tornillo corta

**MERCEDES BENZ**



**TTH8530**

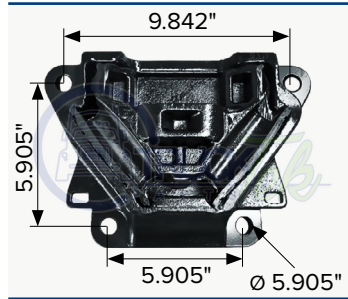

**FREIGHTLINER**

OEM 0133928000

Soporte de motor

**TTH8531**



**FREIGHTLINER**

OEM

Juego de reparación de soporte de motor

**TTH6856**

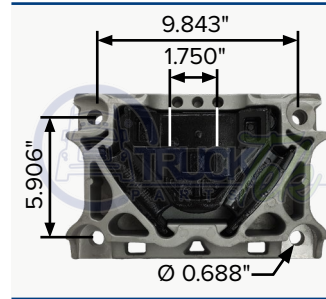

**FREIGHTLINER**

OEM 0134095000

Soporte de motor Freightliner

**PHM-1-2953**



**INTERNATIONAL**

OEM

Soporte de motor tipo ProStar

**PHM-7-6077**

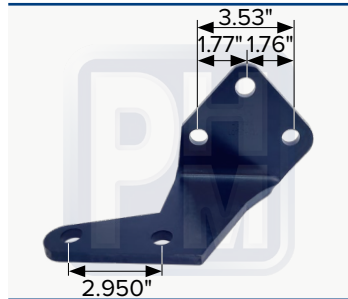

**KENWORTH**

OEM A11-6077

Soporte de motor izquierdo tipo T-660 mod 2012

**PHM-7-6078**

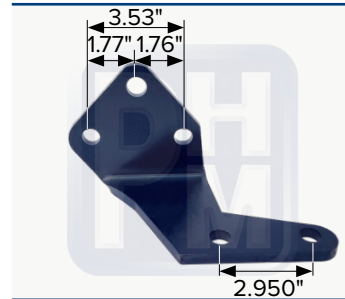

**KENWORTH**

OEM A11-6078

Soporte de motor derecho tipo T-660 mod 2012

**PHM-1-2628**

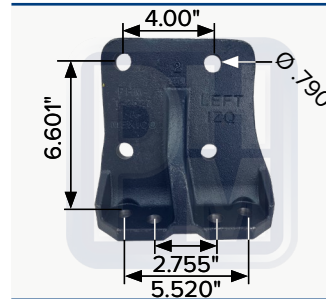

**KENWORTH**

OEM D62414M01R, 142464AA-D12

Soporte derecho trasero de motor

**PHM-1-2627**

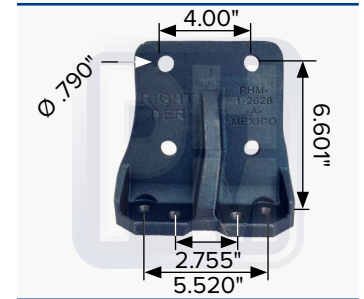

**KENWORTH**

OEM D621144M01L

Soporte izquierdo trasero de motor

**PHM-7-6063L**

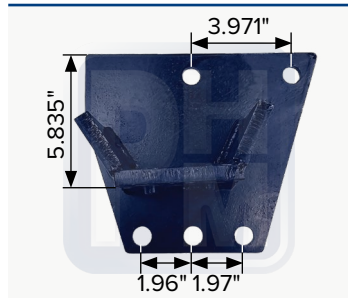

**KENWORTH**

Soporte izquierdo trasero de motor

**PHM-7-6063R**

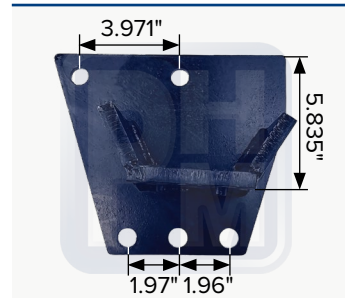

**KENWORTH**

Soporte derecho trasero de motor

**PHM-1-SP15**

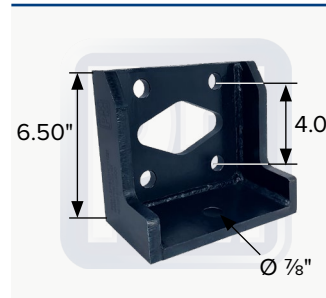

**KENWORTH**

OEM K159-916A

Soporte

**PHM-7-7061**

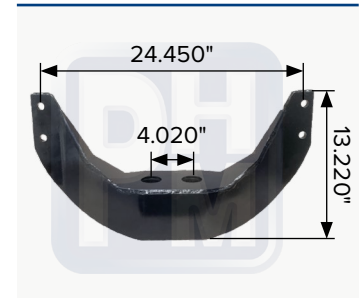

**KENWORTH**

OEM

Soporte de motor

**PHM-7-1584L**

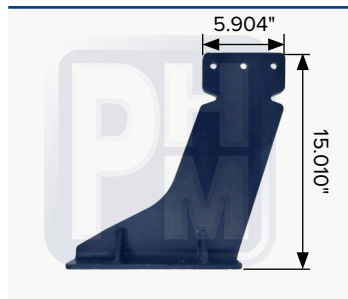

**KENWORTH**

OEM N11-1584

Soporte batería izquierda

**PHM-7-1584R**

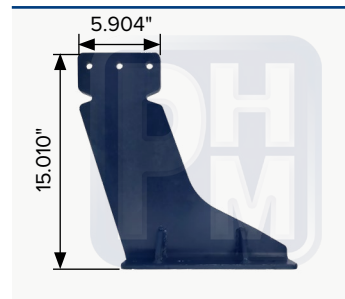

**KENWORTH**

OEM N11-1584

Soporte batería derecha

**TTH9010**

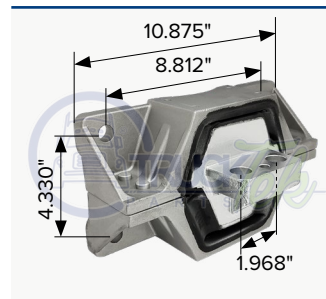

**MACK**

OEM 20QL47AM, 20QL47M, 25070943

Soporte de motor

**TTH0102**

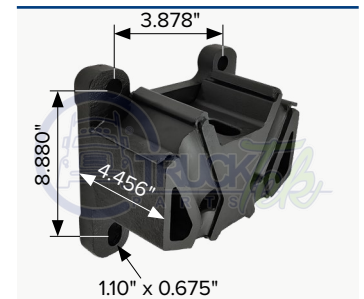

**PETERBILT**

OEM 05250110102

Soporte de motor

## PHM-7-7854L

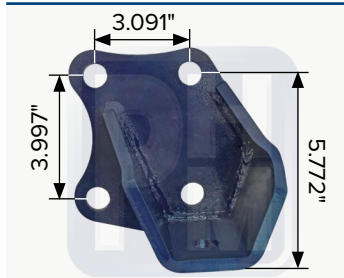

**PETERBILT**

OEM 0525131R

Soporte izquierdo de motor cat C15

## PHM-7-7854R

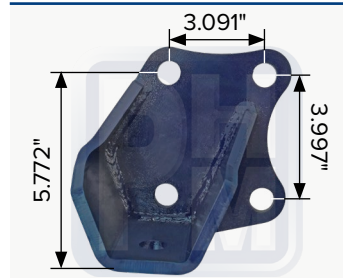

**PETERBILT**

OEM 0525131L

Soporte derecho de motor cat C15

## PHM-7-2236



**KENWORTH**

OEM K054-2236

Soporte escape

## TTH6239

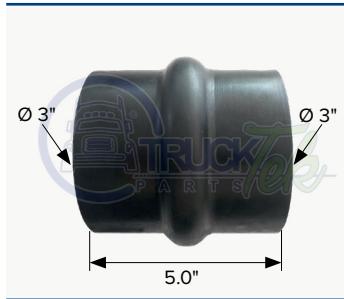

Cople tubo 4" x 4"

## TTH6245

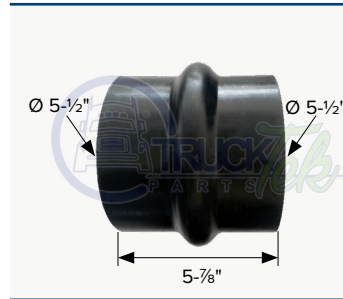

Cople para manguera antivibradora de 5-1/2" x 5-1/2"

**KENWORTH**

## TTH6249



Cople 3" x 3"

## TTH6250

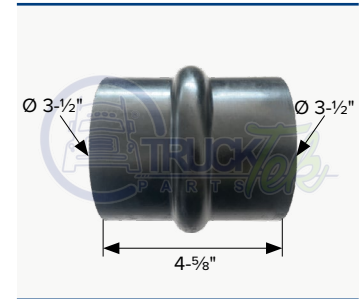

Cople tubo 3-1/2" x 3-1/2"

## TTH6252

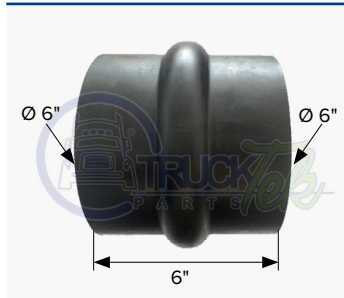

**DINA**

Cople tubo de 6" x 6"

## TTH6253

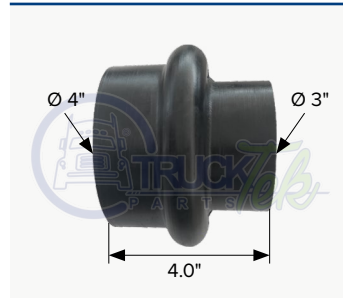

Cople tubo 3" x 4"

## TTH6256

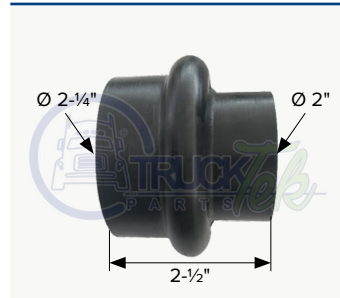

**DINA / INTERNATIONAL**

Cople tubo de 2" x 2-1/4" tipo Dina / Navistar

## TTH6257



**DINA / INTERNATIONAL**

Cople tubo de 2" x 2-1/4" tipo Dina / Navistar

## TTH6258

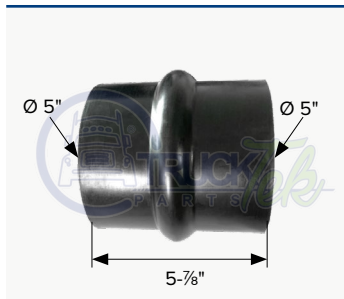

**DINA**

Cople tubo de admisión de 5" x 5"

## TTH6259

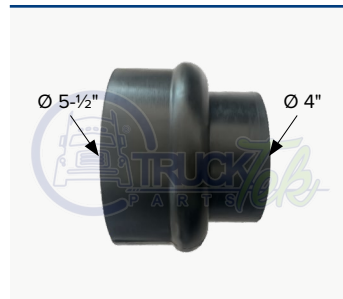

**DINA**

Cople tubo de 4" x 5-1/2"

## TT45193

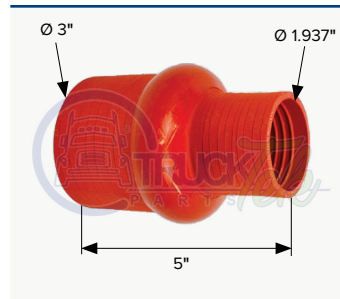

**INTERNATIONAL**

OEM 1659046C1

Reducción de silicón para manguera tipo International

**TTM0001**



**MERCEDES BENZ**

OEM A001 601 501 08 82  
Codo de silicon 4 capas de aramida

**TTM0002**



**MERCEDES BENZ**

OEM A376 094 03 82  
Manguera de silicon 4 capas de aramida

**TTM0003**



**MERCEDES BENZ**

OEM A376 094 70 82  
Manguera de silicon 4 capas de aramida

**TTM0004**

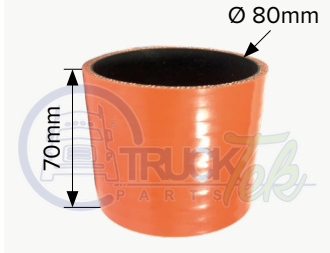

**MERCEDES BENZ**

OEM A382 628 79 82  
Manguera de silicon 4 capas de aramida

**TTM0005**



**MERCEDES BENZ**

OEM A382 528 80 82  
Manguera de silicon 4 capas de aramida

**TTM0006**



**MERCEDES BENZ**

OEM R476 094 70 82  
Manguera de silicon 4 capas de aramida

**TTM0007**



**MERCEDES BENZ**

OEM A664 528 76 82  
Manguera de silicon 4 capas de aramida

**TTM0009**



**MERCEDES BENZ**

OEM A685 528 96 82  
Manguera de silicon 4 capas de aramida

**TTM0010**



**MERCEDES BENZ**

OEM A904 094 11 82  
Manguera de silicon 3 capas de aramida

**TTM0011**

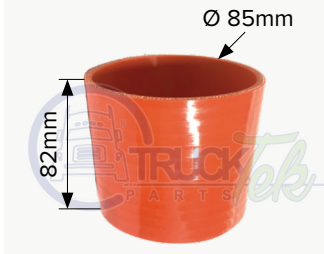

**MERCEDES BENZ**

OEM A685 528 96 82  
Manguera de silicon 3 capas de aramida

**TTM0012**



**MERCEDES BENZ**

OEM A906 094 09 82  
Manguera de silicon 3 capas de aramida

**TTM0013**



**MERCEDES BENZ**

OEM A384 501 14 82  
Manguera de silicon 3 capas de aramida con 3 anillos

**TTM0014**



**MERCEDES BENZ**

OEM A904 094 06 82  
Manguera de silicon 3 capas de aramida con 3 anillos

**TTM0015**

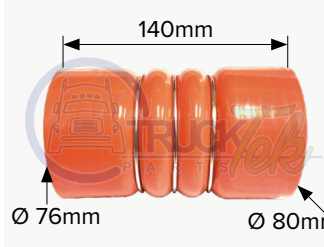

**MERCEDES BENZ**

OEM A384 501 14 82  
Manguera de silicon 4 capas de aramida con 3 anillos

**TTM0016**

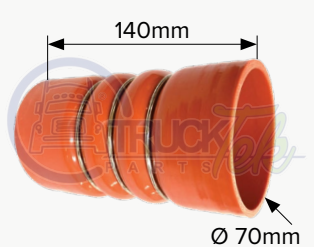

**MERCEDES BENZ**

OEM A904 094 08 82  
Manguera de silicon 3 capas de aramida con 3 anillos

**TTM0019**

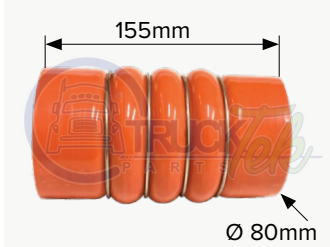

**MERCEDES BENZ**

OEM A386 500 01 75  
Manguera de silicon 4 capas de aramida con 4 anillos

## TTM0021

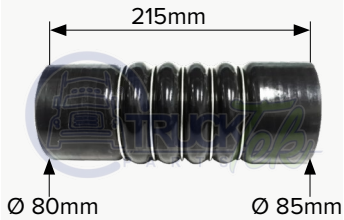

### MERCEDES BENZ

OEM A696 500 70 75

Manguera de silicón 3 capas de aramida con 5 anillos

## TTM0022



### MERCEDES BENZ

OEM A384 501 14 82

Manguera de silicón 4 capas de aramida con 5 anillos

## TTM0023



### MERCEDES BENZ

OEM A696 500 72 75

Manguera de silicón 3 capas de aramida con 5 anillos

## TTM0024

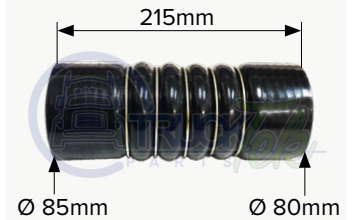

### MERCEDES BENZ

OEM A906 094 06 82

Manguera de silicón 3 capas de aramida con 5 anillos

## TTM0025

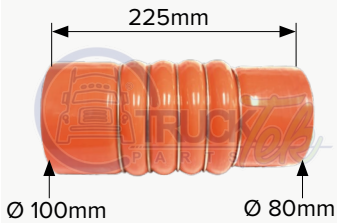

### MERCEDES BENZ

OEM A384 500 07 75

Manguera de silicón 3 capas de aramida con 5 anillos

## TTM0026

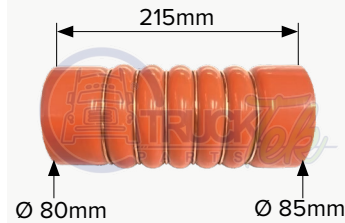

### MERCEDES BENZ

OEM A382 500 01 75

Manguera de silicón 4 capas de aramida con 6 anillos

## TTM0027

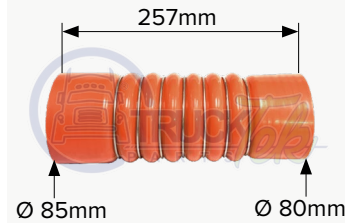

### MERCEDES BENZ

OEM A384 500 07 75

Manguera de silicón 3 capas de aramida con 7 anillos

## TT66310400

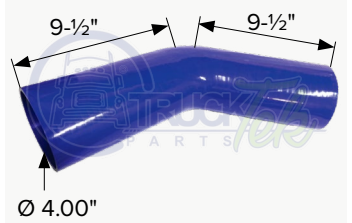

### MERCEDES BENZ

Manguera de silicón 3 capas de aramida en codo de 45°

## TTH6240



### DINA / KENWORTH

Codo para Dina 90° 5-1/2" x 5-1/2"

## TTH6242



### DINA

Codo de 90° 4" x 4"

## TTH6246



### DINA

Codo tubo de admisión de 90° 6" x 6"

## TTH6247



Ø 3"

Codo 90° 3" x 3"

## TTH6264



Ø 5"

Codo 90° 5" x 5-1/2"

## TTH6265



Ø 4-1/2"

Codo 90° 4-1/2" x 4-1/2"

## TTH6243



Ø 4"

Codo con cople purificador

## TTH6275



### DINA / INTERNATIONAL

Codo de 90° 3-1/2 X 3-1/2 tipo Dina / Navistar

**TTRETF003**

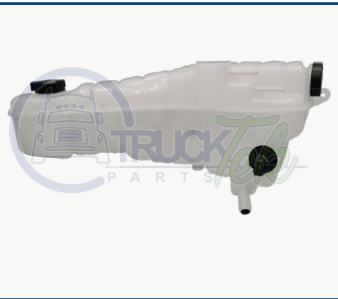

**FREIGHTLINER**

OEM A0528531000

Tanque recuperador de anticongelante

**TTRETF007**

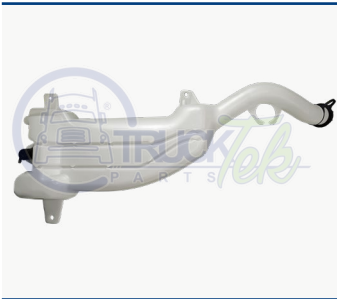

**FREIGHTLINER**

OEM A22-609552-004

Tanque de agua para limpia brisas

**TTRETF008**

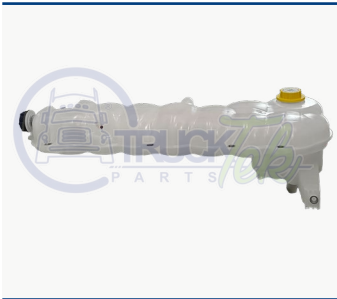

**FREIGHTLINER**

OEM A052836000

Tanque recuperador de anticongelante

**TTRETK002**



**KENWORTH**

OEM N5355001

Tanque de agua para limpia brisas

**TTRETP1043**



**KENWORTH**

OEM N5346001

Tanque recuperador de anticongelante

**TTRETI006**

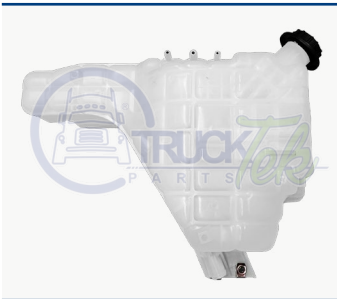

**INTERNATIONAL**

OEM 38400116F94

Tanque recuperador de anticongelante

**TTRETI007**



**INTERNATIONAL**

OEM 2602935C91

Tanque recuperador de anticongelante

**TTRETI008**



**INTERNATIONAL**

OEM 2587172C93

Tanque recuperador de anticongelante

**TTRETI009**

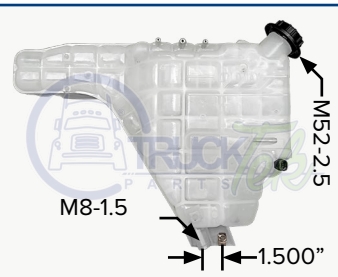

**INTERNATIONAL**

OEM 4062314C1, 296C3

Tanque recuperador de anticongelante

**TT6109**

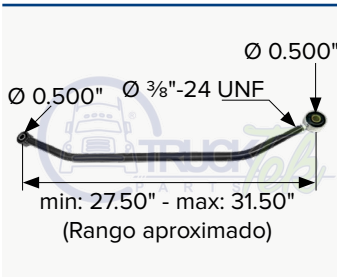

**FREIGHTLINER**

Varilla de clutch

**PHM-3-TSR1414**

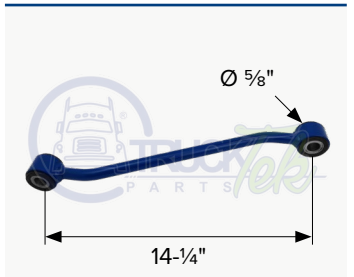

**KENWORTH**

OEM F65-6058-350088  
Tensor de radiador

**PHM-3-TSR1334**

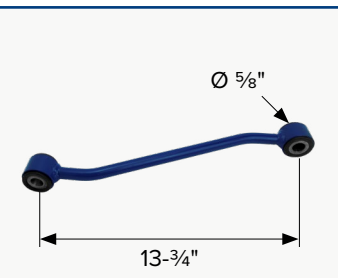

**KENWORTH**

Tensor de radiador

**PHM-3-TSR2200**

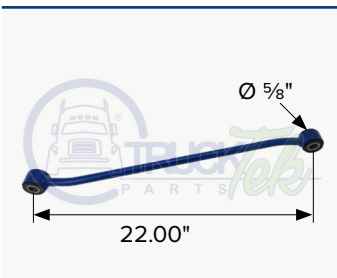

**KENWORTH**

Tensor de radiador

**PHM-3-TSR2458**

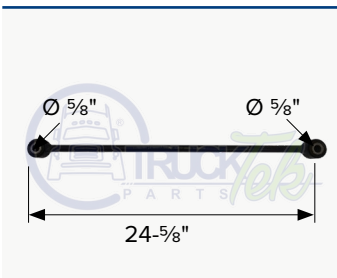

**KENWORTH**

Tensor soldado para buje de torsión de 5/8"

**PHM-3-TSR2500**

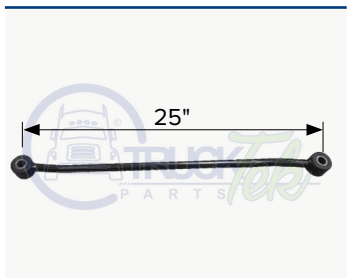

**KENWORTH**

OEM F656058637094  
Tensor de radiador de 25"

## TTFCTHERMO



Tapón recuperador tanque anticongelante tipo Termo

## TTFCTHERMO2



Tapón para tanque diesel tipo Termo 2

## TTFCMERCEDES



MERCEDES BENZ

Tapón para tanque diesel

## TTFCFAMSA



FAMSA

Tapón para tanque diesel

## TTFCFL



FREIGHTLINER

Tapón para tanque diesel

## TTFCM2



FREIGHTLINER

Tapón para tanque diesel tipo M2

## TTFCFLPERNO



FREIGHTLINER

Tapón para tanque diesel tipo FL PERNO

## TTFCIHC



INTERNATIONAL

Tapón para tanque diesel roscado tipo International IHC normal

## TTFCIGDE



INTERNATIONAL

Tapón para tanque diesel

## TTFCKWALTO



KENWORTH

Tapón para tanque diesel tipo Kenworth alto

## TTFCKWVIEJO



KENWORTH

Tapón para tanque diesel tipo Kenworth viejo

## TTFCKW



KENWORTH

Tapón para tanque diesel tipo Kenworth normal

## TTFCV1



VOLVO

Tapón para tanque diesel tipo Volvo 1

## TTFCV2



VOLVO

Tapón para tanque diesel tipo Volvo 2

## TTH1003Q



Tapón para bayoneta de aceite

## TTH2751



Tapón para aceite cromado

**PHM-1-3138A**



**KENWORTH**

Araña delantera izquierda tipo Bendix

**PHM-1-3138B**



**KENWORTH**

Araña delantera derecha tipo Bendix

**PHM-1-3139L**



**KENWORTH**

Araña delantera izquierda tipo Bendix

**PHM-1-3139R**



**KENWORTH**

Araña delantera derecha tipo Bendix

**PHM-7-0911**



**HENDRICKSON**

Araña de frenos tipo Intraax, Vantraax

**PHM-7-0912**

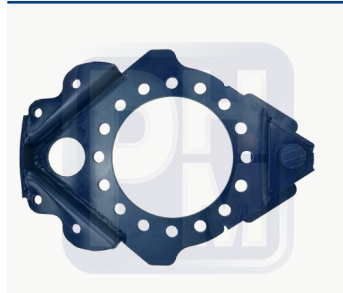

**HENDRICKSON**

OEM 69 3867BR2

Araña

**PHM-7-0913**



**EATON**

Araña eje trasero

**PHM-1-3212F**



**MERITOR**

Araña izquierda

**PHM-1-3212G**



**MERITOR**

Araña derecha

**PHM-7-0909**



Araña de 5.740" de diametro

**PHM-7-4860**

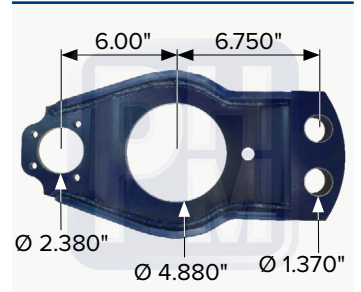

**GENERICA**

OEM

Araña porta zapata soldable

## TCF0164



**CUMMINS**

OEM DVC13010DAV

Cubierta de filtro de diesel con tapa y rosca de sujeción

## TCF0310



**CUMMINS**

OEM DVC102420

Cubierta de filtro de diesel

## TCF1037



**CUMMINS**

OEM DVC240023DAV

Tapa para filtro de gasolina

## TTFA1004



Manguera para rotochamber 3/8" x 48"

## TTFA1005



Juego de manitas para frenos azul y rojo

## TTFA1007



Conector de aire azul atornillable trasero para remolque

## TTFA1008



Conector de aire rojo atornillable trasero para remolque

## PHM-D-11315



Juego de mangueras de aire 15" pies de largo para frenos azul y roja

## TT12105



Valvula de drenado

## TT0706



Conector macho 3/8" NPT

## PHM-7-9004615



Válvula piloto de eje retráctil de tres vías

## TVTR545D



Valvula curva

## TVV3204



**ISUZU**

Valvula curva

## TVV3205



Valvula curva

## TVTR573



Valvula recta



**PHM-3-9033**



Buje separador de eje delantero

**PHM-M-71696B75**



Tapon maza trasera de 6 barrenos

**PHM-7-ME011**



Soporte de cámara

**PHM-7-0555**



OEM 070-42710563  
Soporte de ajuste para matraca

**PHM-M-12013**



Maza delantera 5 birlos

**PHM-M-12016**



Maza delantera 9 birlos

**PHM-M-12477**

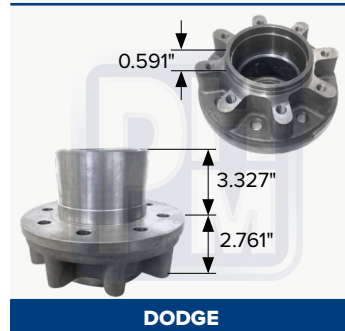

Maza trasera DODGE RAM 4000 de 8 birlos

**PHM-M-12478**

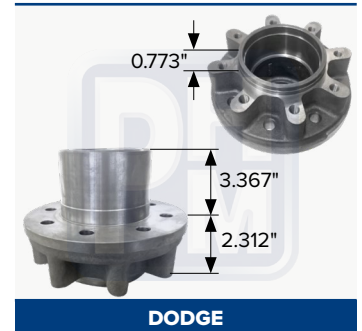

Maza tipo D-350 MOD 2012

**PHM-M-12479**

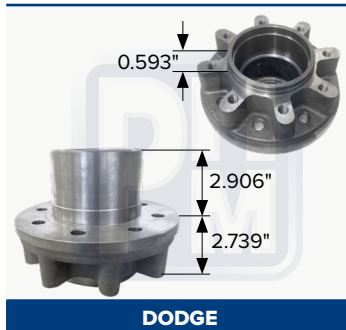

Maza trasera D-350 frenado de disco

**K2122**



Juego de reparación gavlán disco  
OEM E2122

**K2212**



Juego de reparación gavlán  
OEM E1357A

**K2086**



Juego de reparación gavlán  
OEM E2122

**7WA075019**

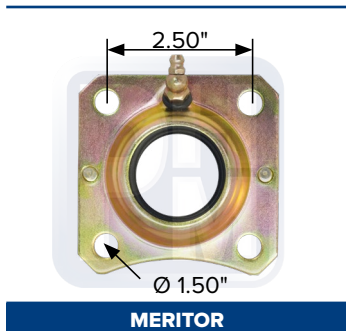

Buje para porta gavlán  
OEM A23105G1151

**K5515**



Kit de reparación para porta zapatas  
OEM

**K1205**

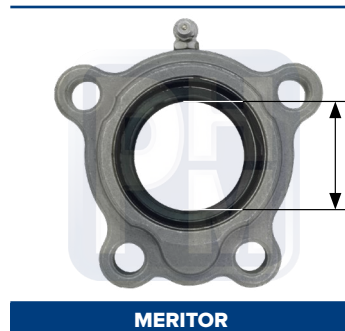

Buje gavlán  
OEM A3105L1078

**7WA102626**



Valvula relay R12  
OEM 65181

## TTSECAD9

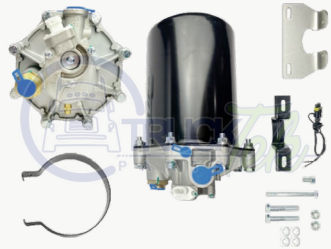

**VOLVO**

Secador de aire

## TTSECADIS



**KENWORTH**

Secador de aire

## TTSECAD109994



**KENWORTH**

OEM 109994  
Cartucho secador repuesto

## TTSECAD5016364



**BENDIX**

OEM 5016364  
Secador ADIS 12V

## TTSECAD107794



**VOLVO**

OEM 170107796  
AD9 Repuesto

## TTSECADCASADIA



**FREIGHTLINER**

OEM 170.432471  
Secador para cascadia 12V

## PH17148



Resorte de 20"

## PHM-7-R168



**MERITOR**

Rondana para gavilanes

## PHM-7-R209



**MERITOR**

Rondana

## 7KBL0125

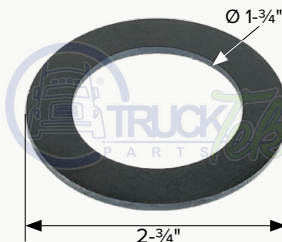

Laina para perno dirección

## M50024



Reten para maza 5 birlos 2000 libras

## TT2010412C92



**INTERNATIONAL**

OEM 2010412C92  
Bomba hidráulica de dirección

## PHM-3-8575

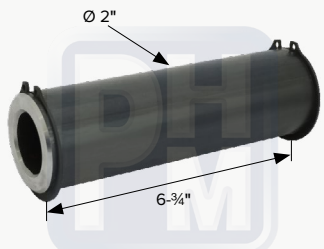

**PREMIER**

OEM  
Pasador de bisagra 2" X 6-3/4" con seguros

## TTDSI2

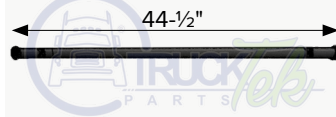

**ISUZU**

OEM  
Barra transversal

## TTDSCHEV



**GMC**

OEM  
Brazo para Kodiak

**TTDS852G050160**

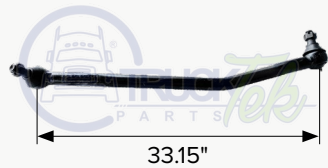

**INTERNATIONAL**

OEM BR-1664845C92  
Brazo de dirección para revoladora 7400 MOD 77631072 izquierda tipo Dina, motor Coach Industries

**TTDS1448**



**FORD / STERLING**

OEM F6HZ3304DA, DS1448, L24VU8098A11, L24VU8098B11  
Brazo de dirección

**TTDS1276**



**FREIGHTLINER**

OEM 1412349000, 14-12349-000  
Brazo de dirección

**TTDS4674**



**FREIGHTLINER**

OEM  
Brazo de dirección

**TTDSFGM201**



**FREIGHTLINER**

OEM  
Brazo de dirección tipo Freightliner M2

**TTDS4697**

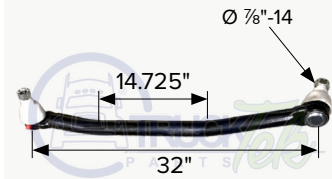

**FREIGHTLINER**

OEM 1415497000, 14-15497-000, 1417312000, LV24VU8417A12  
Brazo de dirección

**TTDMS2**



**FREIGHTLINER**

OEM  
Brazo de dirección para Freightliner Cascadia Evolution

**TTDS1419429000**



**FREIGHTLINER**

OEM  
Brazo de dirección para Freightliner Cascadia Evolution

**TTDSHINO02**



**HINO**

OEM  
Brazo de dirección tipo Hino 300

**TTDS55241**



**INTERNATIONAL**

OEM 3558241C91  
Brazo de dirección

**TTDS5566**

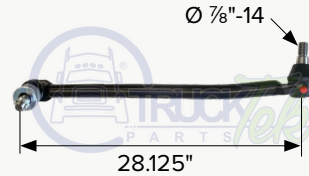

**INTERNATIONAL**

OEM 15004025, 3500966C91  
Brazo de dirección

**TTDS55242**

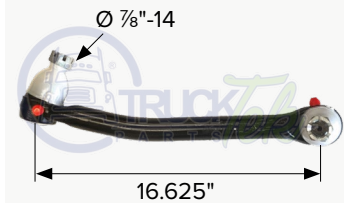

**INTERNATIONAL**

OEM 3558242C91, 3541118C91  
Brazo de dirección

**TTDSM001**

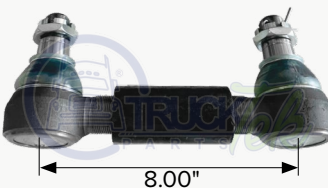

**MERCEDES BENZ**

OEM  
Brazo de dirección

**TTDSJ206011**



**KENWORTH**

OEM J20-6011  
Brazo longitudinal tipo Kenworth T680

**TTDSWORKERVW**



**VOLKSWAGEN**

Brazo de dirección izquierdo y derecho tipo Worker

**TTDS1419512000**



**FREIGHTLINER**

Barra de dirección para cascadia

## SD1119007



**FOTON**

OEM

Terminal de dirección

## SD1119008



**FOTON**

OEM

Terminal de dirección

## TTDS1010



Brazo de dirección

## TTDS6258



**MACK**

OEM

Brazo de dirección

## TTDSK001

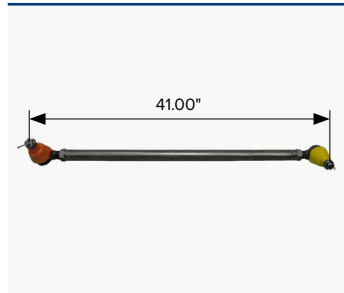

**FREIGHTLINER**

OEM

Brazo de dirección con terminales TTES2090 y TTES2091

## TDF005

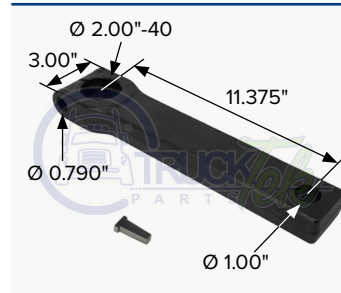

**FREIGHTLINER**

OEM

Brazo Pittman para Freightliner

## TDK005

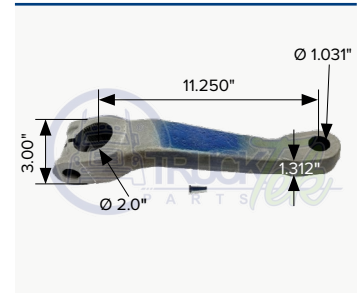

**KENWORTH**

OEM

Brazo pitman tipo Kenworth, Peterbilt

## TDV005



**VOLVO**

OEM

Brazo Pitman para Volvo

## TC1078CK



**KENWORTH**

OEM

Repuesto de tanque de dirección

## TC1027



**KENWORTH**

OEM J86-6001

Tanque de aceite para dirección hidráulica

## TC1028



**KENWORTH**

OEM J866005

Tanque de aceite para dirección hidráulica

## TC1029



**KENWORTH**

OEM J861047001

Tanque de aceite para dirección hidráulica

## TTOS002



**FREIGHTLINER**

OEM 14-17060-000

Tanque de aceite para dirección

## TTOS003



**FREIGHTLINER**

OEM 14-17060-000

Tanque de aceite para dirección

## TTOS001



**VOLVO**

OEM

Tanque de aceite de dirección

**PHM-7-3095**

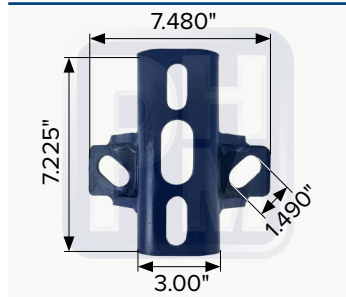

**HOLLAND**

OEM XE-0154-1

Soporte "T" rotochamber para gancho

**PHM-7-XA01997**



**HOLLAND**

OEM XA01998

Perno quinta rueda para Holland

**PHM-7-XA01998**



**HOLLAND**

OEM XA01997

Tornillo de ajuste quinta rueda tipo Holland

**PHM-7-0592**



Manivela corta para patín quinta rueda

**PHM-3-2180**

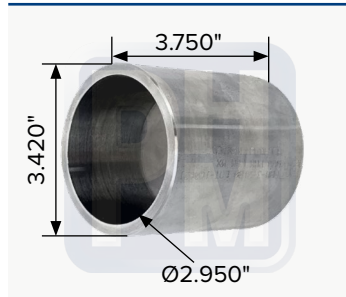

**GENÉRICO**

Buje para reparación de enganche de dolly cónico

**TTQ129**



**HOLLAND**

Perno Rey de 3/8" de acero forjado

**PHM-7-2858**



**FONTAINE**

OEM KIT-RPR-5092L

Kit reparacion para quinta rueda

**PHM-3-3500**



**HOLLAND**

OEM

Juego de zapatas de desgaste Quinta Rueda, Superior

**PHM-7-2864**



**JOST**

OEM 65181

Kit para reparación quinta rueda

**PHM-7-2866**



**JOST**

OEM SK312160

Juego de reparación derecho

**D72862**



**JOST**

OEM

Anillo de reparación

**PHM-7-2518**



**JOST**

OEM SK212151

Anillo de reparación

**PHM-7-2516**

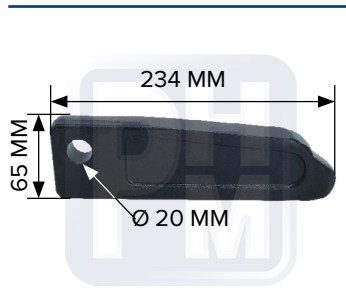

**JOST**

OEM SK320506

Barra seguro

**TTH0594**

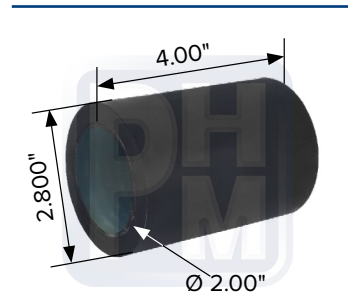

**JOST**

OEM SK290594, SK29095

Buje para quinta rueda

## PHM-1-5539

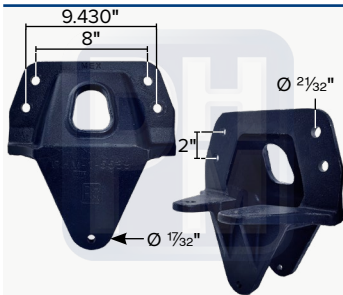

**HENDRICKSON**

OEM 50182-1

Percha intermedia tipo RTE

## PHM-1-5540

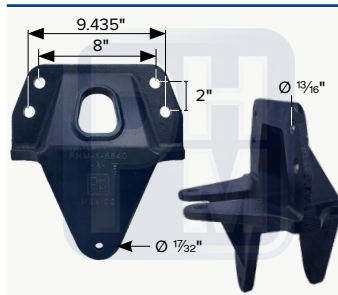

**HENDRICKSON**

OEM 50183001, F4HT5894AA

Percha trasera para suspensión tipo RTE

## PHM-1-5055



**FREIGHTLINER**

Percha parte columpio

## PHM-1-4061



**VOLVO**

OEM 371120003, 3082273

Percha delantera der/izq para perno roscado milimétrico

## PHM-7-2040L

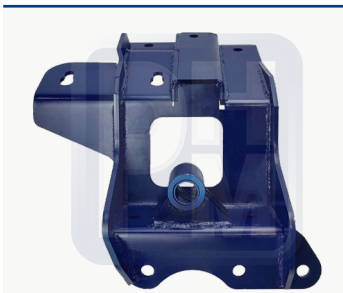

**ISUZU**

OEM 48433-2040

Percha R4 izquierda

## PHM-7-2040R



**ISUZU**

OEM 48433-2040

Percha R4 derecha

## PHM-7-6783



**DAYTON**

Percha trasera derecha tipo Dayton

## PHM-7-6784



**DAYTON**

Percha trasera izquierda tipo Dayton

## PHM-7-8414

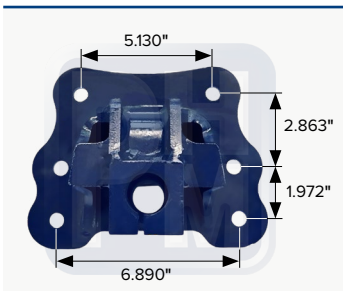

**HINO**

OEM E02001, 48414

Percha para Hino 700

## PHM-7-8416

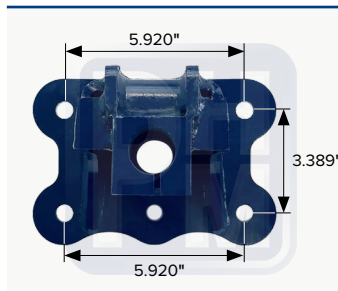

**HINO**

OEM E0080, 48416

Percha trasera para Hino 500

## PHM-7-1900L

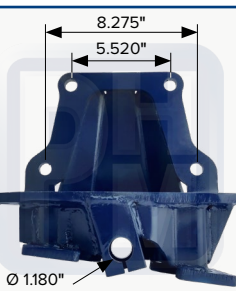

## PHM-7-8855

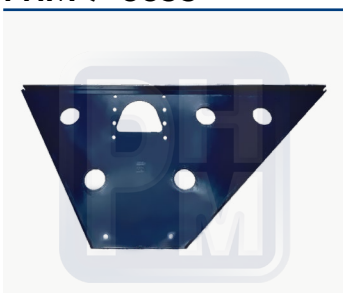

**GENÉRICO**

Percha remolque con base para patín derecha

## PHM-7-8855E



**GENÉRICO**

Percha remolque con base para patín izquierda

## PHM-7-8857



**GENÉRICO**

Percha trasera izquierda para remolque rear hanger LH

## PHM-7-8858



**GENÉRICO**

Percha trasera trasera izquierda tipo remolque

**PHM-7-8101**



**FREIGHTLINER**

OEM 16-18289-000

Percha delantera suspensión delantera derecha tipo M2

**PHM-7-8100**



**FREIGHTLINER**

OEM 16-18289-000

Percha delantera suspensión delantera izquierda tipo M2

**PHM-7-8827**

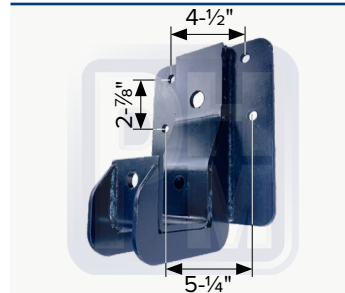

**CHEVROLET**

Percha trasera

**PHM-7-75001**

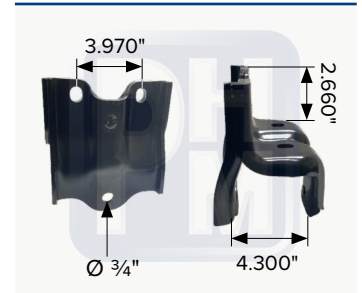

**FREIGHTLINER**

Percha delantera

**PHM-1-7017**



**KENWORTH**

B11-1025 REV,  
B04088AE10009783CMI04PM02

Percha delantera izquierda

**PHM-1-7018**



**KENWORTH**

B11-1025 REV,  
B04088AE10009783CMI04PM02

Percha delantera derecha

**PHM-7-1720**



**KENWORTH**

Percha delantera izquierda

**PHM-7-1721**



**KENWORTH**

Percha delantera derecha

**PHM-7-0058**

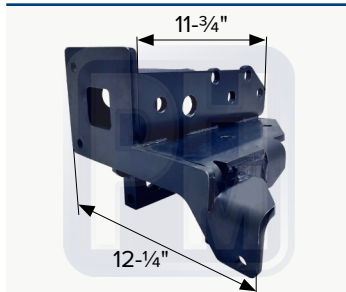

**KENWORTH**

Percha derecha tipo W900

**PHM-7-0059**

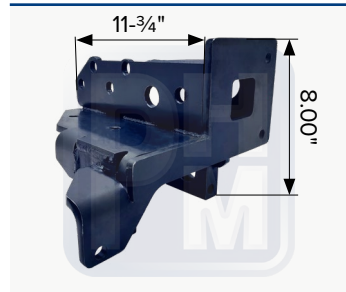

**KENWORTH**

Percha izquierda tipo W900

**PHM-7-0060R**



**KENWORTH**

OEM K058-150R  
Percha derecha tipo W900-A

**PHM-7-0061L**



**KENWORTH**

OEM K058-150  
Percha izquierda tipo W900-A

**PHM-7-0063**



**KENWORTH**

Percha derecha

**PHM-7-0064**



**KENWORTH**

Percha izquierda

**PHM-7-9514**



**KENWORTH**

OEM K058-511  
Percha delantera suspensión delantera izquierda

**PHM-7-9513**



**KENWORTH**

OEM K058-511R  
Percha delantera suspensión delantera derecha

## PHM-7-6201R

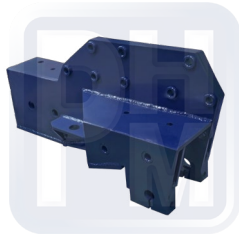

**PETERBILT**

OEM 0146201R

Percha delantera derecha

## PHM-7-6201L

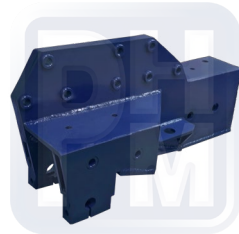

**PETERBILT**

OEM 0146201L

Percha delantera izquierda

## PHM-1-1023



**KENWORTH**

OEM B111023

Percha roscada milimétrica

## PHM-1-1024



**KENWORTH**

OEM B116011

Percha con buje

## PHM-7-0042

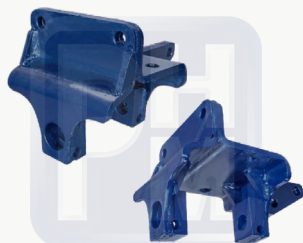

**KENWORTH**

Percha delantera suspensión delantera

## PHM-1-3998



**HENDRICKSON**

OEM 50028001

Percha trasera

## PHM-7-5080LH

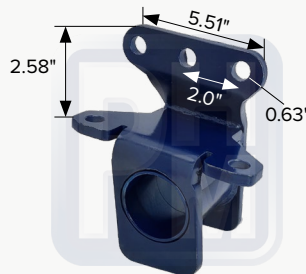

**HENDRICKSON**

OEM 64176002

Percha derecha tipo AirTek

## PHM-7-5081RH

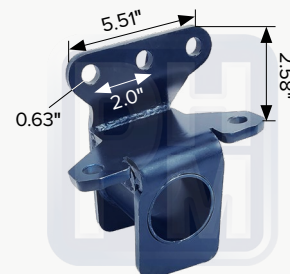

**HENDRICKSON**

OEM 64176001

Percha izquierda tipo AirTek

## PHM-7-8412

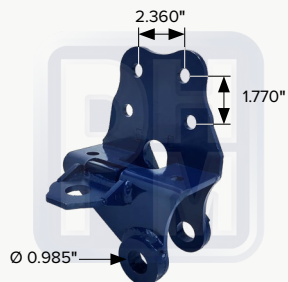

**HINO**

OEM S48411-2401

Percha paleta

## PHM-7-8413

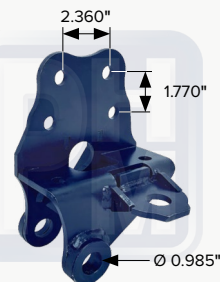

**HINO**

OEM S48142-1431

Percha paleta

## PHM-7-0037

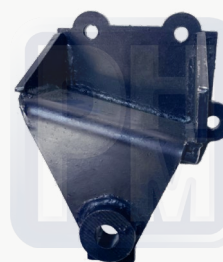

**FORD**

Percha trasera suspensión delantera izquierda para camión F-600

## PHM-7-0038



**FORD**

Percha trasera suspensión delantera derecha para camión F-600

## PHM-1-5054



**FREIGHTLINER**

Percha delantera

## PHM-1-5053



**FREIGHTLINER**

OEM 16-16091-021

Percha delantera

## PHM-7-8040

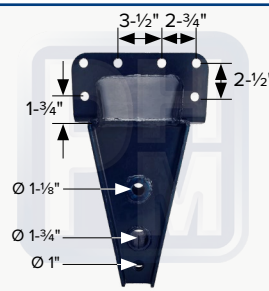

**HUTCH**

OEM 1617801

Percha central atornillable de 1-1/8" tipo serie 9700

## PHM-1-5027AR



**INTERNATIONAL**

Percha trasera suspensión delantera izquierda



**PHM-1-3812**



**INTERNATIONAL**

Percha delantera derecha tipo ProStar modelo 2012

**PHM-1-3813**



**INTERNATIONAL**

Percha delantera izquierda tipo ProStar modelo 2012

**PHM-7-8839**



**NISSAN**

Percha trasera izquierda tipo NP-300

**PHM-7-8840**



**NISSAN**

Percha trasera derecha tipo NP-300

**PHM-7-8841**



**NISSAN**

Percha suspension trasera tipo NP-300

**PHM-7-5621**

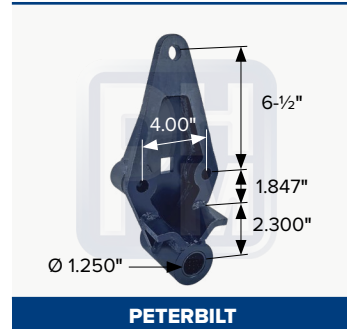

**PETERBILT**

OEM 3381230A

Percha delantera

**PHM-7-8024**

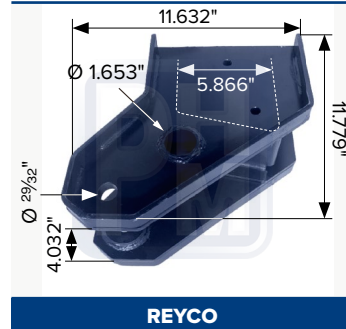

**REYCO**

Percha delantera

**PHM-7-2004L**



**MERCEDES BENZ**

OEM P9829018

Percha trasera izquierda

**PHM-7-2004R**



**MERCEDES BENZ**

OEM P9829018

Percha trasera derecha

**PHM-7-2005L**



**MERCEDES BENZ**

OEM 9829018, Z08S03, 55013

Percha delantera izquierda

**PHM-7-2005R**



**MERCEDES BENZ**

OEM 9829018, Z08S03, 55013

Percha delantera derecha

**PHM-7-6754**



**VOLVO**

OEM MV96754

Percha delantera suspensión trasera derecha

## PHM-7-S73A

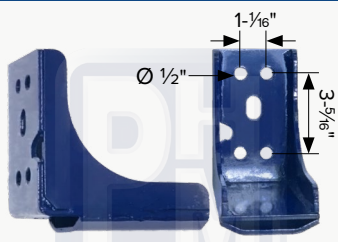

**CHEVROLET**

Soporte de sobre carga delantero suspensión trasera

## PHM-1-8039

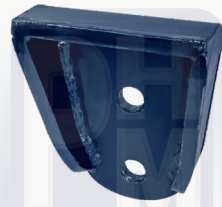

**INTERNATIONAL**

OEM 3553944C3

Tope sobrecarga delantero para ProStar

## PHM-7-S73G

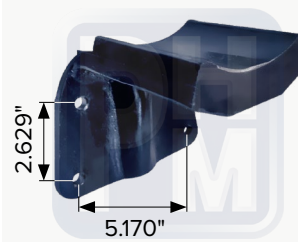

**CHEVROLET**

Soporte de sobrecarga tipo HD 3500

## PHM-7-S70D



**FORD**

Soporte PARA F-350, F-450 mod. 99-2000 vulcanizado

## PHM-7-1712

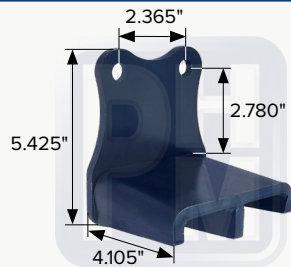

**HINO**

OEM 48418-E0070

Soporte de sobrecarga Helper 5/16 para Hino

## PHM-7-0080

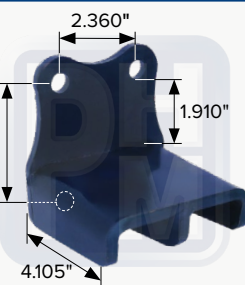

**HINO**

OEM

Percha de sobre carga

## PHM-7-5018

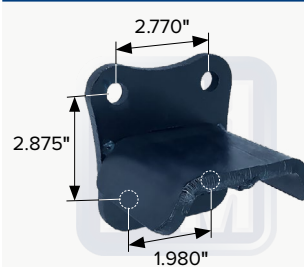

**ISUZU**

OEM 7715018, 1-53356059-1

Soporte de sobrecarga

## PHM-7-8804

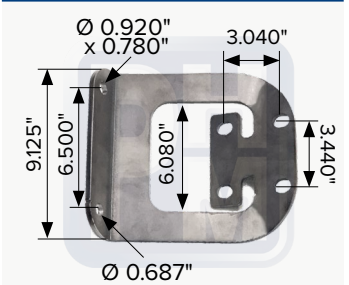

**KENWORTH**

Soporte marco interior

## PHM-7-2458L

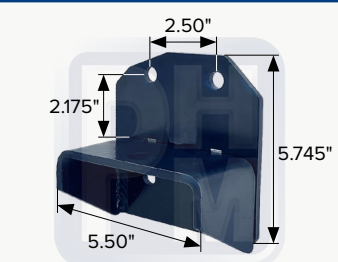

**KENWORTH**

OEM D6-110-001

Soporte de montaje izquierdo

## PHM-7-2458R

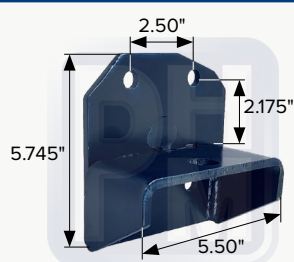

**KENWORTH**

OEM D6-110-001

Soporte de montaje derecho

## PHM-7-1241

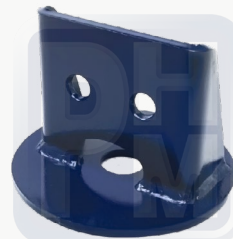

**KENWORTH**

OEM B11-6013

Soporte bolsa de aire suspensión delantera

## PHM-3-7546

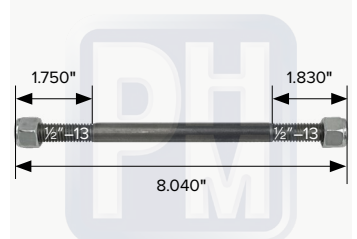

**KENWORTH**

OEM MPB7546

Birlo para bolsa de aire

## PHM-7-8812



**HENDRICKSON**

Soporte

## PHM-7-R998

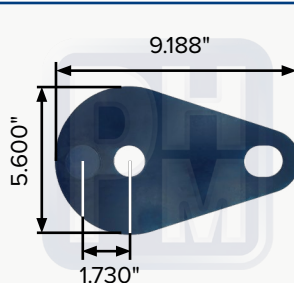

**NEWAY**

OEM 90531339

Base rondana Galuz

## PHM-7-1234



**VOLKSWAGEN**

Resbalon tipo VW Worker

**PHM-7-8823**



**MERITOR**

Percha con soporte izquierda

**PHM-7-8824**



**MERITOR**

Percha derecha tipo Meritor

**PHM-7-8830**



**MERITOR**

Percha derecha tipo Meritor

**PHM-7-8829**

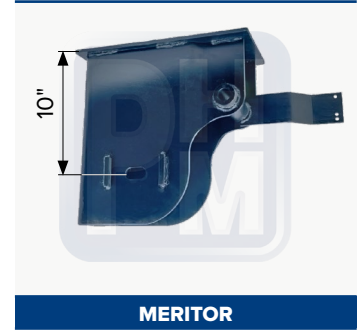

**MERITOR**

Percha izquierda tipo Meritor

**PHM-7-7703**



**HENDRICKSON**

Percha suspensión de aire izquierda

**PHM-7-7704**



**HENDRICKSON**

Percha suspensión de aire derecha

**PHM-7-7703A**



**HENDRICKSON**

Percha suspensión de aire izquierda

**PHM-7-7704A**

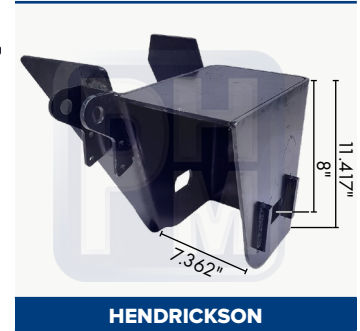

**HENDRICKSON**

Percha suspensión de aire derecha

**PHM-7-7806**

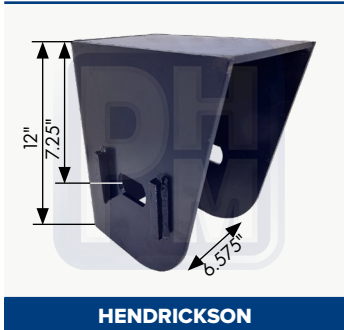

**HENDRICKSON**

Percha suspensión de aire izquierda

**PHM-7-7807**

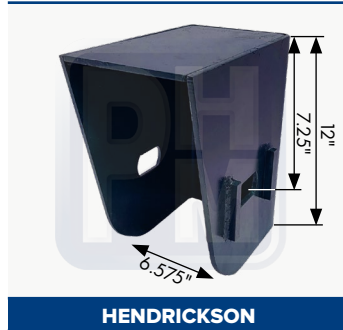

**HENDRICKSON**

Percha suspensión de aire derecha

**PHM-7-7808**

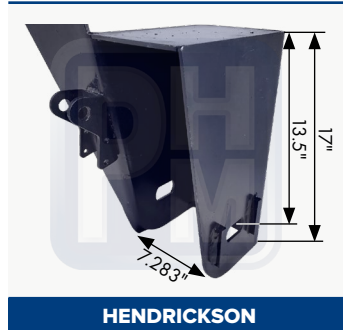

**HENDRICKSON**

Percha suspensión de aire derecha

**PHM-7-7809**

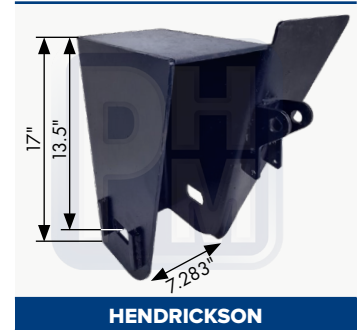

**HENDRICKSON**

Percha suspensión de aire izquierda

**PHM-7-8029A**

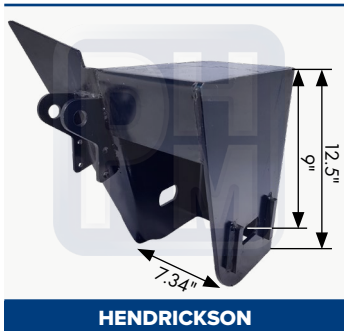

**HENDRICKSON**

Percha para suspension de aire buje trifuncional grueso alineación rápida izquierda tipo HT-300

**PHM-7-8029B**

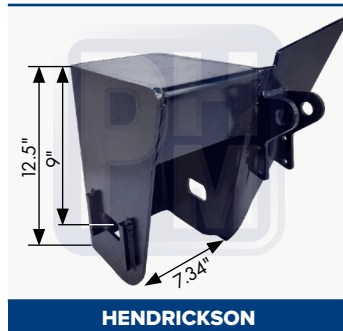

**HENDRICKSON**

Percha para suspension de aire buje trifuncional grueso alineación rápida derecha tipo HT-300

**PHM-7-8837**

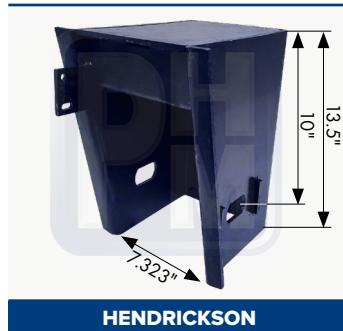

**HENDRICKSON**

Percha alineación rápida izquierda tipo HT-300

**PHM-7-8838**

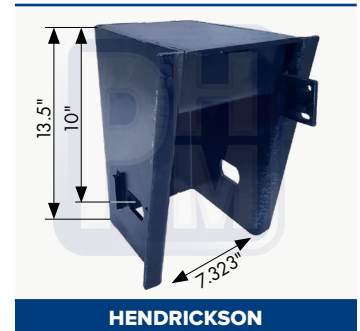

**HENDRICKSON**

Percha alineación rápida derecha tipo HT-300

## PHM-7-7843

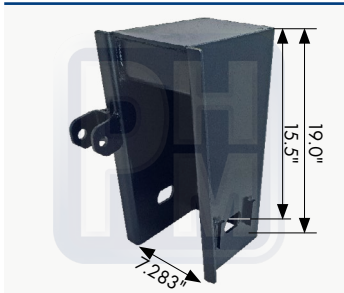

**HENDRICKSON**

- Para buje trifuncional grueso
- Con pestañas
- Para tornillo de alineación rápida

## PHM-7-7844

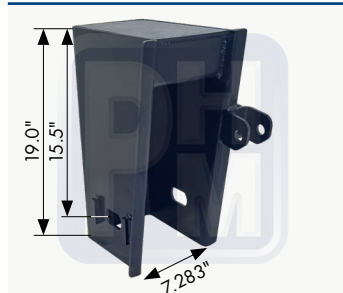

**HENDRICKSON**

- Para buje trifuncional grueso
- Con pestañas
- Para tornillo de alineación rápida

## PHM-7-7837

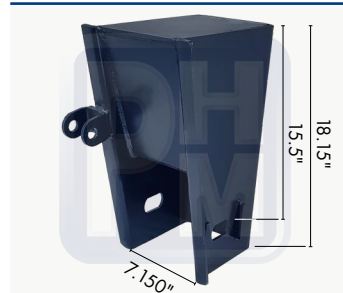

**HENDRICKSON**

- Para buje trifuncional grueso
- Con pestañas
- Para tornillo de alineación rápida

## PHM-7-7838

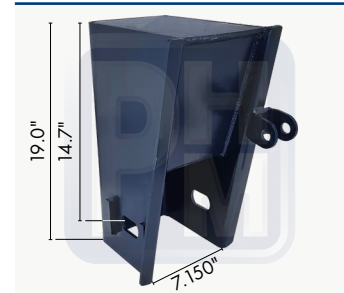

**HENDRICKSON**

- Para buje trifuncional grueso
- Con pestañas
- Para tornillo de alineación rápida

## PHM-7-9906R

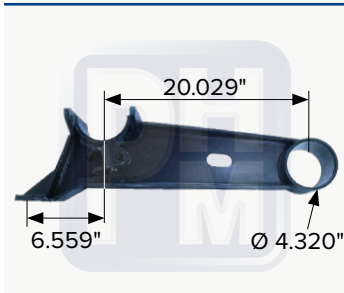

**NEWAY**

OEM

Pierna fabricada derecha

## PHM-7-9906L

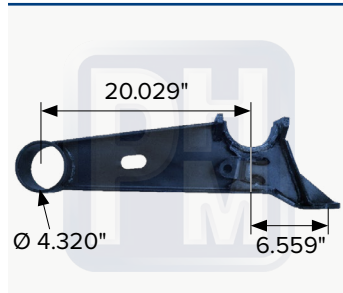

**NEWAY**

OEM

Pierna fabricada izquierda

## PHM-7-8815LH

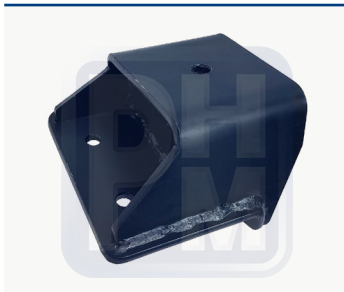

**HENDRICKSON**

Soporte de de bolsa de aire izquierdo tipo Intraax Vantraax

## PHM-7-8815RH

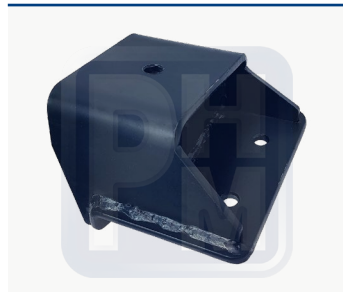

**HENDRICKSON**

Soporte de de bolsa de aire derecho tipo Intraax Vantraax

## PHM-7-0091L

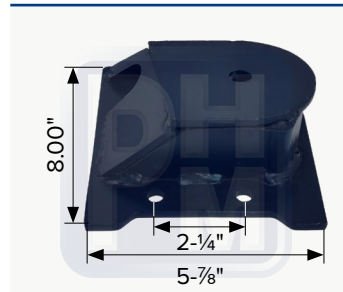

**HENDRICKSON**

Soporte de de bolsa de aire izquierdo tipo Intraax

## PHM-7-0090R

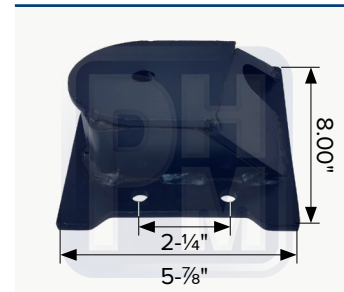

**HENDRICKSON**

Soporte de de bolsa de aire derecho tipo Intraax

## PHM-7-8833

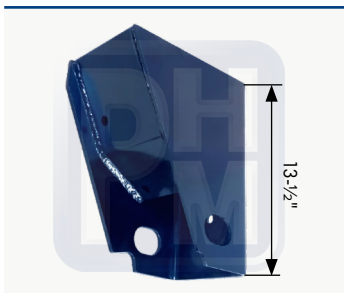

**NEWAY**

Percha suspension de aire izquierda

## PHM-7-8834

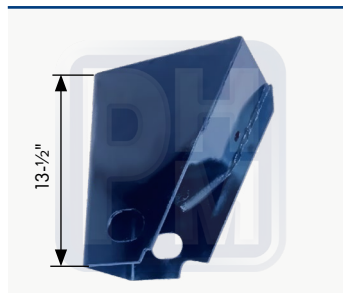

**NEWAY**

Percha suspension de aire derecha

## PHM-7-5167



**NEWAY**

Pierna izquierda

## PHM-7-5168



**NEWAY**

Pierna derecha

**PHM-7-2535**



**FREIGHTLINER**

Soporte de amortiguador inferior izquierdo

**PHM-7-2536**



**FREIGHTLINER**

Soporte de amortiguador inferior derecho

**PHM-3-8002**



**FREIGHTLINER**

Soporte de amortiguador inferior izquierdo

**PHM-3-8003**



**FREIGHTLINER**

Soporte de amortiguador inferior derecho

**PHM-7-9990L**



Soporte de amortiguador izquierdo

**PHM-7-9990R**



Soporte de amortiguador derecho

**PHM-7-9991L**



Soporte de amortiguador izquierdo

**PHM-7-9991R**



Soporte de amortiguador derecho

**PHM-7-1680**

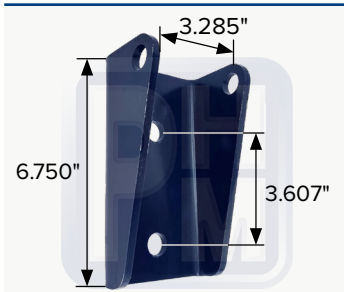

**KENWORTH**

Soporte de amortiguador

**PHM-7-9998**



Soporte de amortiguador

**PHM-7-1240**



Soporte de amortiguador tipo Dolly

**PHM-3-0044**

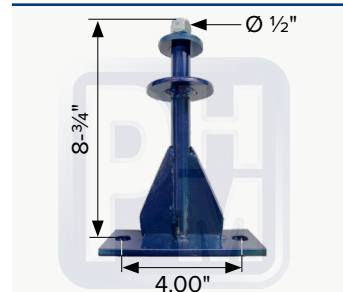

**FREIGHTLINER**

Soporte de amortiguador

**PHM-7-1003**



**INTERNATIONAL**

Soporte de amortiguador superior delantero

**PHM-7-9852**



**VOLVO**

Soporte de amortiguador

**PHM-7-0008**

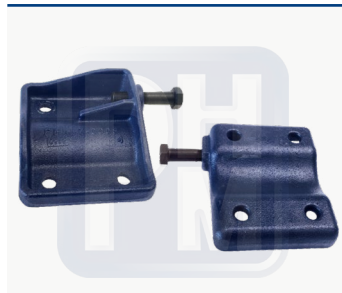

**MITSUBISHI**

Tapa inferior amortiguador tipo L200

**PHM-7-2002**

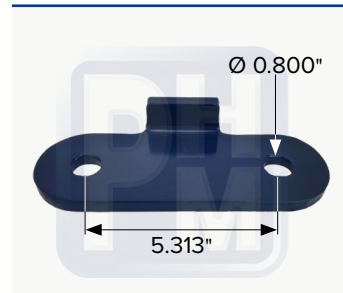

**FREIGHTLINER**

Eslabón

OEM 16-20985-000

## PHM-7-0006

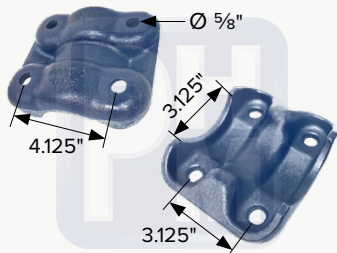

**CHEVROLET**

OEM 15711787, 25761308

Tapa de diferencial tipo Silverado P/U '99-'07, Suburban base '00-'14, Suburban 2500 '07-'14, Yukon 4 DOO XL '07-'14,

## PHM-1-3451



**FREIGHTLINER**

Asiento de eje redondo 5"

## PHM-1-6190

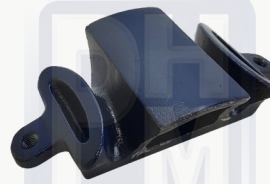

**FREIGHTLINER**

Sobre muelle

## PHM-7-8856



**FREIGHTLINER**

Asiento de muelle

## PHM-1-7016



**INTERNATIONAL**

Cuña de 6°

## PHM-7-8798

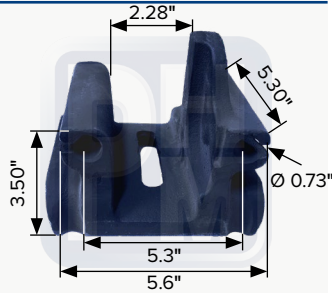

**HENDRICKSON**

Sobre muelle

## PHM-1-8771



**HENDRICKSON**

Asiento separador

## PHM-1-7700



**HUTCH**

Tapa inferior en placa

## PHM-7-4833



**HINO**

OEM 48372-E0020

Sobre muelle suspensión delantera

## PHM-1-7015



**INTERNATIONAL**

Cuña 3.5° tipo ProStar

## PHM-1-0669



**INTERNATIONAL**

Sobre muelle delantero tipo ProStar

## PHM-1-5526



**KENWORTH**

OEM B201002, B201008  
Eslabon de muelle

## PHM-1-1761

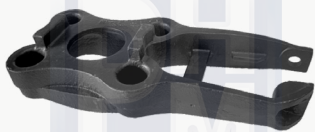

**MACK**

OEM 20541761

Sobre muelle

## PHM-7-8828

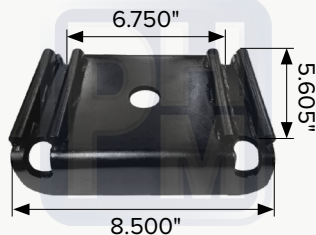

**NEWAY**

OEM 91010021

Sobre muelle

## PHM-1-1022



**NEWAY**

Sobre muelle

## PHM-7-1250

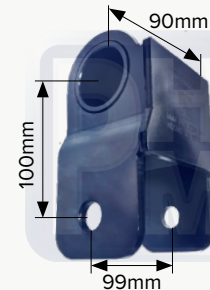

**GMC CHEVROLET**

OEM 15587778

Columpio tipo GMC Kodiak TopKick, 90-02

**PHM-7-1290**

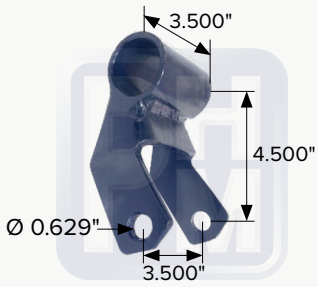

**FORD**

OEM 1C3Z5776BA, 3C3C5776AB, 3C3Z5776AB, F81Z5776CA  
Columpio

**PHM-7-1291**

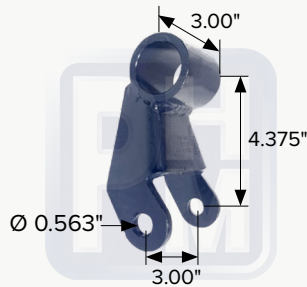

**FORD**

OEM 15049656, 15075657, 15124395, 15529599, 15640442  
Columpio

**PHM-7-6025**



**MITSUBISHI**

Columpio traser tipo Mitsubishi L200 Pickup

**PHM-7-6013**

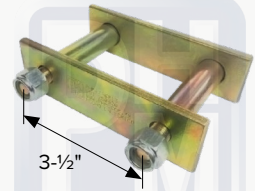

**NISSAN**

Columpio tipo NP300 mod 2017

**PHM-3-1516L**



**HINO**

Columpio izquierdo de 30 mm

**PHM-3-1516R**



**HINO**

Columpio derecho de 30 mm

**PHM-1-5056**



**HINO**

Columpio derecho de 30 mm

**PHM-1-4066**

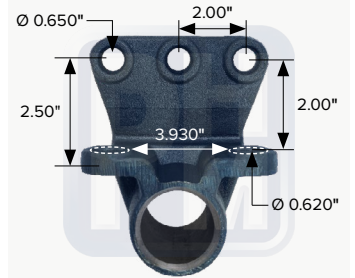

**VOLVO**

OEM MV1657  
Percha parte columpio para buje TTH3294

**PHM-7-5013A**

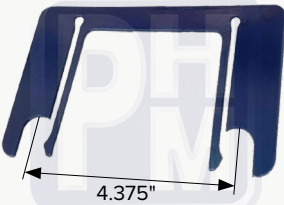

Laina de ajuste espesor 1/32"

**PHM-7-5013B**

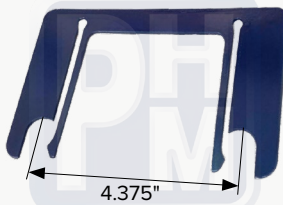

Laina de ajuste espesor 1/16"

**PHM-7-5013C**



Laina de ajuste espesor 1/8"

**PHM-7-MFL72**

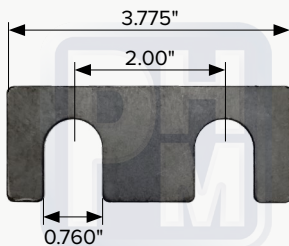

**FREIGHTLINER**

Laina de ajuste espesor 1/32"

**PHM-7-MFL77**

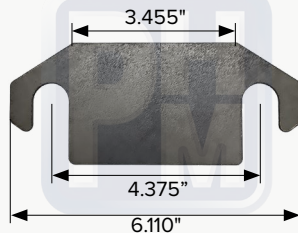

**FREIGHTLINER**

Laina de ajuste espesor 1/32"

**PHM-7-MFL112**

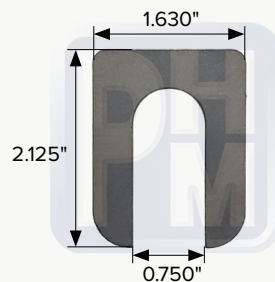

**FREIGHTLINER**

Laina de ajuste espesor 1/32"

**PHM-7-MPB341**

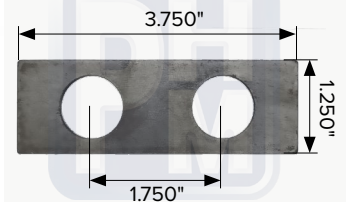

**PETERBILT**

Laina de ajuste espesor 1/32"

## PHM-7-8826



**FREIGHTLINER**

OEM 680-310-37 LSI, 680-312-24-870

Puente tipo M2

## PHM-7-1524

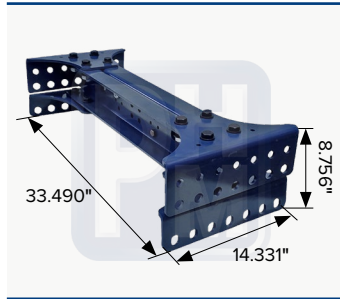

**FREIGHTLINER**

OEM 1524360000

Puente de 21 barrenos para Cascadia

## PHM-7-8888

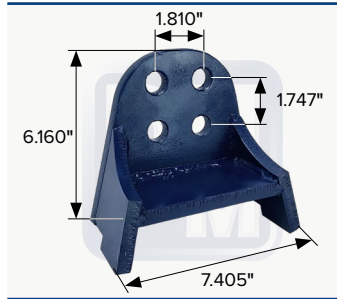

**FREIGHTLINER**

Tope de rebote

## PHM-7-6149

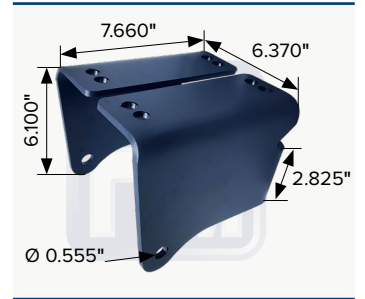

**FREIGHTLINER**

Soporte delantero suspensión trasera tipo aleta tiburón

## PHM-7-0046A

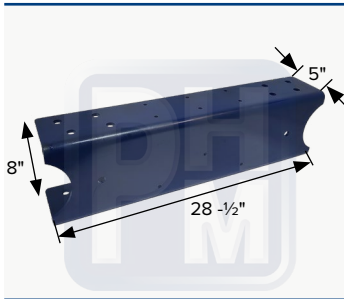

**HENDRICKSON**

Puente de 16 barrenos de 23-1/2"

## PHM-7-0046B

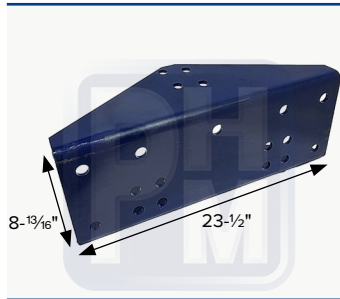

**HENDRICKSON**

Triangulo izquierdo de 23-1/2" x 9 1/8"

## PHM-7-0046C

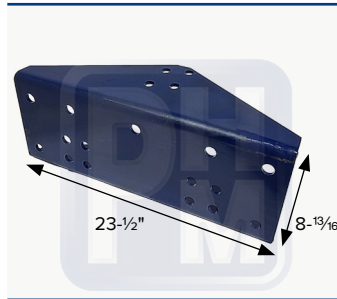

**HENDRICKSON**

Triangulo izquierdo de 23-1/2" x 9 1/8"

## PHM-7-0046KIT

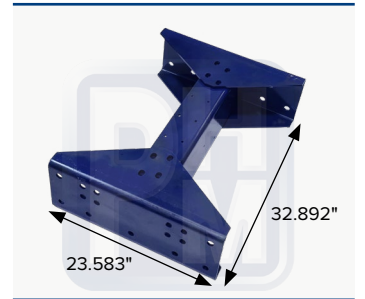

**HENDRICKSON**

Kit soporte de chasis

## PHM-7-2455R

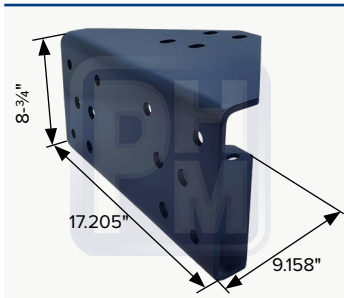

**HENDRICKSON**

Refuerzo interior de chasis en 0.313" derecho

## PHM-7-2455L

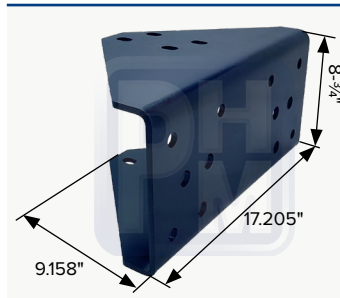

**HENDRICKSON**

Refuerzo interior de chasis en 0.313" izquierdo

## PHM-7-8850C

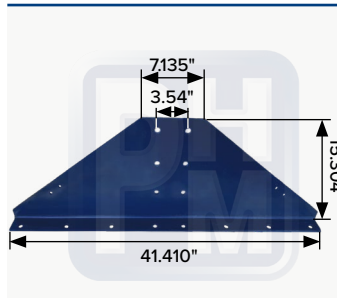

**HENDRICKSON**

Escuadra con 4 barrenos

## PHM-7-8850D

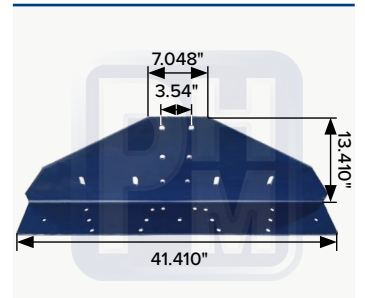

**HENDRICKSON**

Escuadra chasis con galuces

## PHM-7-8850E



**HENDRICKSON**

Refuerzo medio puente

## PHM-7-8851



**HENDRICKSON**

Escuadra chica

## PHM-7-0132

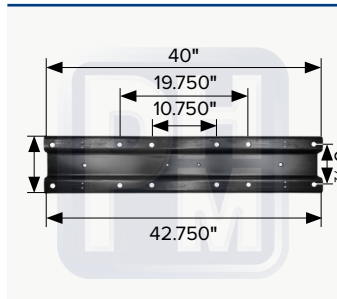

**HENDRICKSON**

OEM 573172, 57317002  
Plancha conectora multi-barreno tipo HAS series

## PHM-7-0133

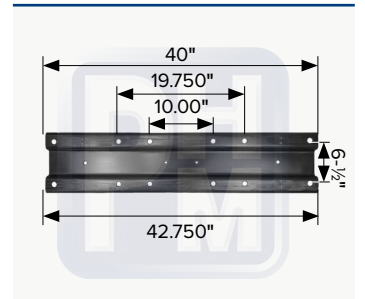

**HENDRICKSON**

OEM 573172, 57317002  
Plancha conectora multi-barreno tipo HAS series



**PHM-7-8801**

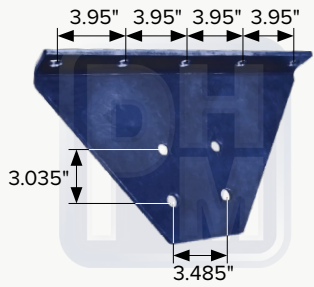

**KENWORTH**

Escuadra para chasis y puente

**PHM-7-8802**

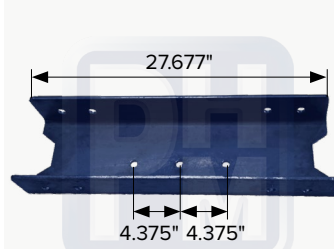

**KENWORTH**

Puente para chasis

**PHM-7-8805**

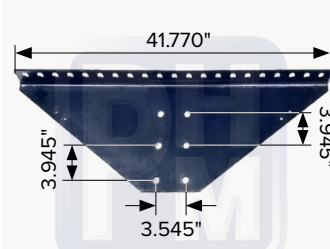

**KENWORTH**

Puente inferior

**PHM-7-8806**



**KENWORTH**

Puente superior

**PHM-7-8810**

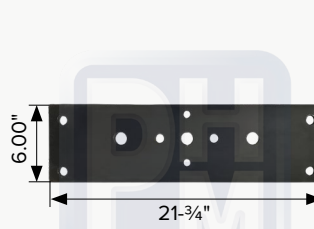

**HENDRICKSON**

Placa de refuerzo puente barrenada

**PHM-7-8811**

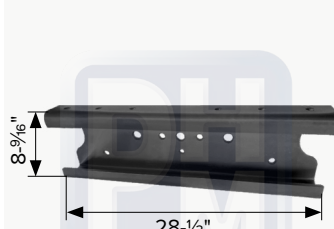

**KENWORTH**

Viga conectora o puente de lamina de 3/8"

**PHM-7-8850A**



**KENWORTH**

Medio puente derecho de 3.455" de grosor

**PHM-7-8850B**



**KENWORTH**

Medio puente derecho de 3.455" de grosor, peso de 17.50 kg

**PHM-7-5441**

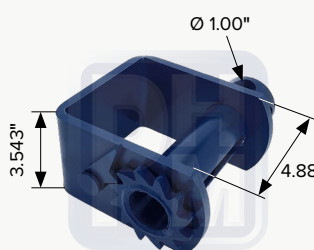

**KINEDYNE**

Trinquete para correa 4"

**PHM-7-8089**

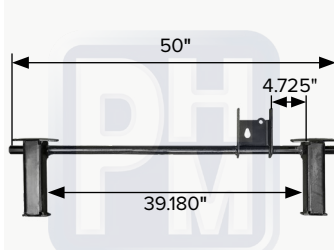

**HENDRICKSON**

Tope de descanso para remolque

**PHM-7-8814**

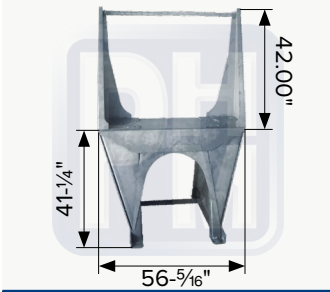

**KENWORTH**

Base trasera para revoladora o trompo de concreto

**TTHK365**



**MACK**

OEM 25121508, 10QK149 Almohadilla para suspensión

**PHM-9-0050**

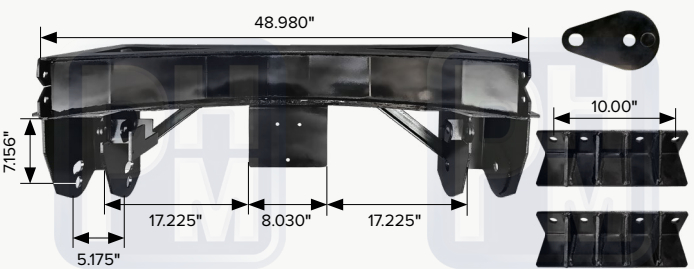

Puente con perchas

**PHM-7-8854**

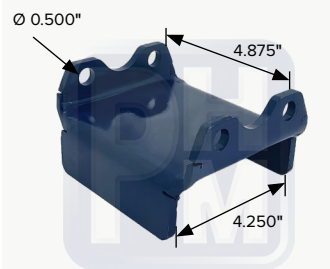

**PETERBILT**

OEM 306219 Zapata de desgaste

## PHM-7-8006

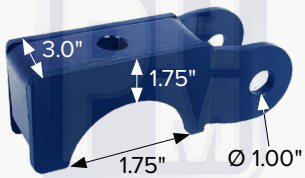

**HUTCH**

Camá redonda 5" 1-3/4" alta muelle 3" perno 1"

## PHM-7-8007



**HUTCH**

Camá redonda 5"

## PHM-1-8008Z



**HUTCH**

Camá redonda

## PHM-7-8009B

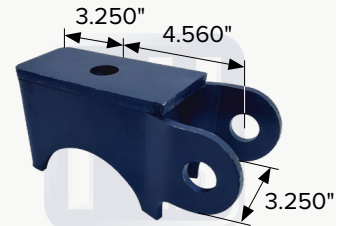

**HUTCH**

Camá redonda de 5" 2-1/2" de alto

## PHM-7-1239



**REYCO**

Base de tensor y asiento de muelle para remolque, redondo 5" tipo TransPro

## PHM-7-8025



**REYCO**

OEM 63601

Camá redonda tipo TransPro

## PHM-7-1518

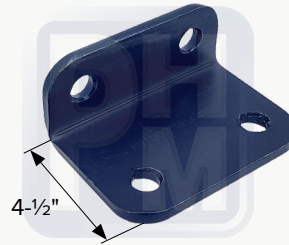

**KENWORTH**

OEM A85-1229

Soporte de defensa inferior

## PHM-7-8853Z

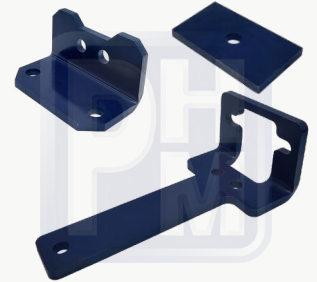

**HENDRICKSON**

OEM 59384000

Juego para silla 7-8853 y 7-8854

## PHM-7-1238

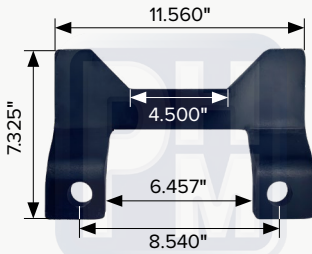

**HENDRICKSON**

Plancha soporte soldable para BAR-PIN

## PHM-7-1247

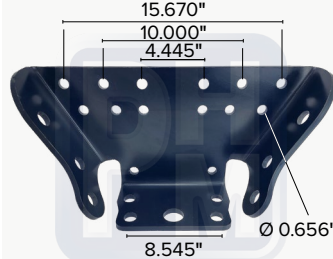

**HENDRICKSON**

Soporte marco exterior cojones

## PHM-7-0051

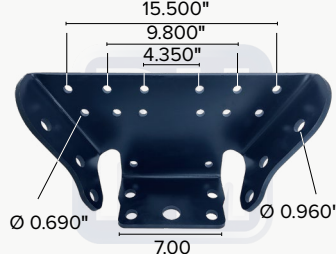

**HENDRICKSON**

OEM 64643000 6442000

Silla de suspensión

## PHM-7-8853



**HENDRICKSON**

OEM 64643000

Silla para suspensión tipo Haulmax

## PHM-7-4890

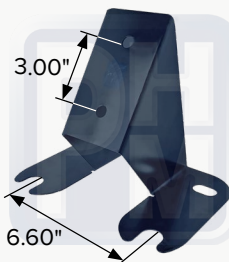

**HENDRICKSON**

OEM 648990000

Placa de desgaste tipo Haulmax

## PHM-7-8343



**HENDRICKSON**

OEM 58343000

"V" para asiento de colchones tipo Hendrickson HN

## PHM-7-7762KC



**HENDRICKSON**

Bisagra sola kit de levante

## PHM-7-7762K



**HENDRICKSON**

Juego de piezas para levante de eje

**PHM-7-2359**



**FUSO**

Perno de 30 mm x 290 mm

**PHM-2-9997**

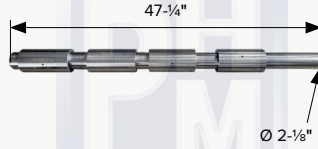

Perno para pistón de volteo con 4 bujes diámetro exterior 4-3/4" con venas de lubricación interior

**PHM-2-9998**

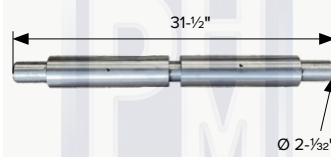

Perno bisagra con dos bujes para cilindro hidráulico

**PHM-2-9999**

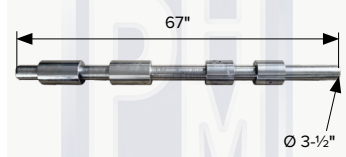

Perno para pistón de volteo con 4 bujes diámetro exterior 3-3/8" con venas de lubricación interior

**PHM-3-9999**

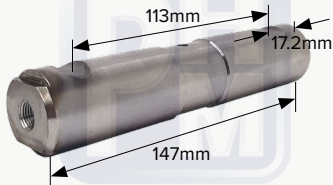

**HINO**

Perno de 30 mm x 147 mm

**PHM-3-2912**



**HINO**

Perno de 30 mm x 150 mm

**PHM-3-2483**



**KENWORTH**

Perno superior para amortiguador

**PHM-1-2120**



**REYCO**

OEM 21206000  
Perno para balancín tipo Reyco 21B de 1-5/8" x 11.500"

**PHM-3-3207**

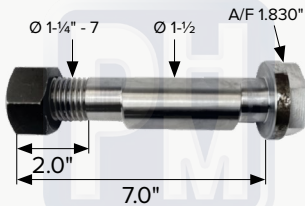

**RIDEWELL**

OEM 1130003  
Perno excéntrico 1-1/2" X 7-3/4"

**PHM-3-3208**

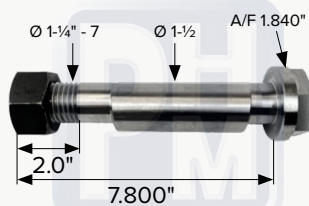

**RIDEWELL**

OEM 1130009  
Perno excéntrico 1-1/2" x 7.800" rosca corta

**PHM-3-3209**

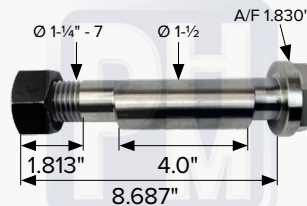

**RIDEWELL**

OEM 1130003  
Perno excéntrico 1-1/2" x 8.687" rosca corta

**PHM-3-3210**

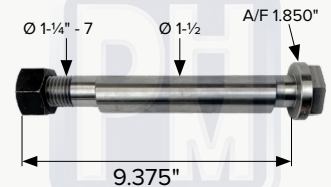

**RIDEWELL**

OEM 1130003  
Perno excéntrico 1-1/2" x 15/16" rosca corta

**PHM-3-3211**

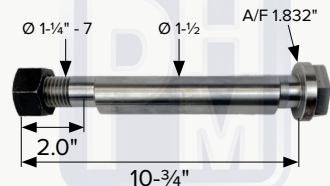

**RIDEWELL**

Perno excéntrico 1-1/2" x 10-3/8"

**PHM-3-0063**



**MACK**

Barra central de suspensión

**PHM-3-5538**



**VOLVO**

Perno roscado

**PHM-5-8007**

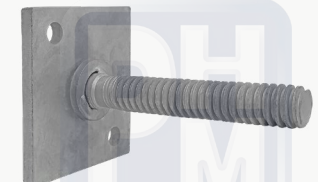

**NEWAY**

OEM 90548007  
Tornillo de alineación

## PHM-7-1243



**HENDRICKSON**

OEM 07500594

Viga balanceadora de 44,000 lbs.

## PHM-9-0088



**HUTCH**

OEM 21206000

Balancín de 72"

## PHM-7-1245

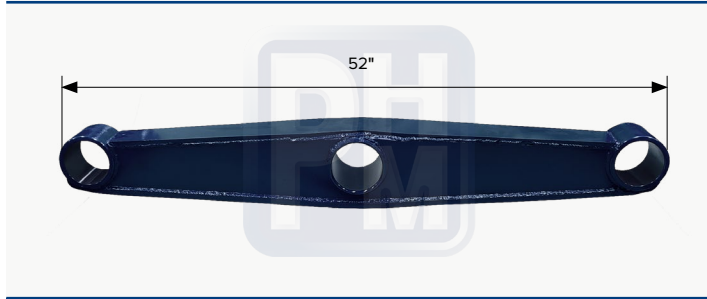

**HENDRICKSON**

OEM

Viga balanceadora de 44,000 lbs.

## PHM-7-3094

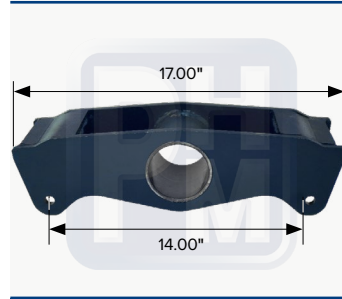

**HINO**

OEM EQ017

Balancin para Peterbilt

## PHM-7-1656



**PETERBILT**

OEM

Soporte cónico para granada

## PHM-7-3225

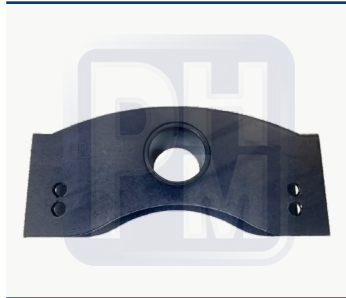

**BINKLEY**

OEM SP0131

Balancín

## PHM-3-9110

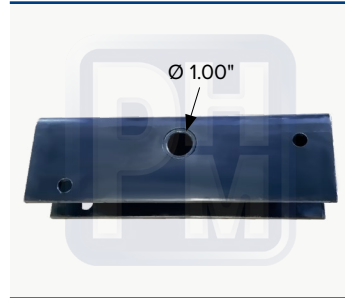

**REMOLQUE**

OEM

Balancin para remolque tipo

## PHM-7-7600

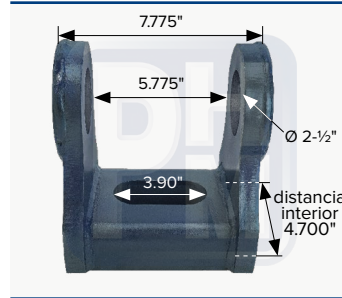

**HENDRICKSON**

OEM

Arete recto fabricado en placa

## PHM-7-7601

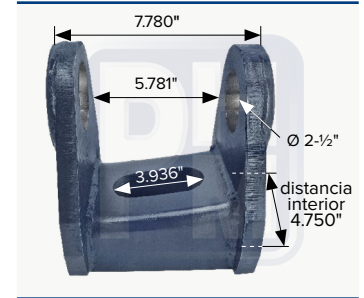

**HENDRICKSON**

OEM

Arete inclinado fabricado en placa

## PHM-7-8808

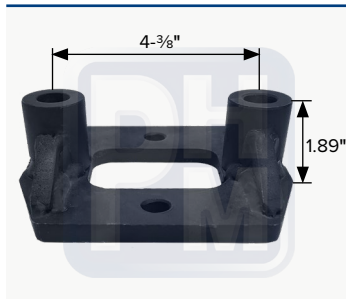

**HENDRICKSON**

Separador de tensor tipo Hendrickson

## PHM-7-8809

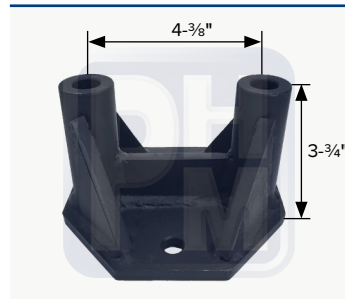

**HENDRICKSON**

Separador de buje de tensor tipo Hendrickson revoladora

## PHM-7-6199



**MACK**

OEM 564.46302

Chumacera con buje de acero

## PHM-7-6200



**MACK**

OEM M1206

Chumacera 5" X 5"

**PHM-2-2124**



**REYCO**

Soporte extensible

**PHM-3-TS20MOD**



Tensor soldable para modificar de 20"

**PHM-7-66C1**

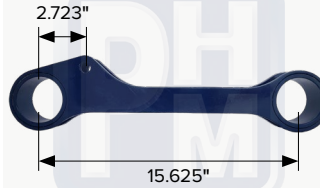

**HENDRICKSON / INTERNATIONAL**

OEM 3609966C1  
Tensor fijo

**PHM-3-3458**



**INTERNATIONAL**

Tensor suspensión delantera tipo ProStar

**PHM-7-4835**



**HENDRICKSON**

OEM TMR5935  
Tensor fijo 17-1/8"

**PHM-7-4875**



**HENDRICKSON**

OEM TMRR5975  
Tensor fijo 18.700"

**PHM-1-5702**

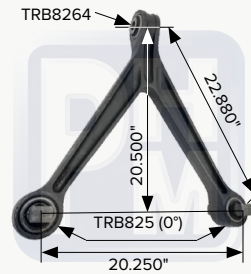

**NEWAY**

Tensor en "V"

**PHM-7-5489**



**NEWAY**

OEM 95489  
Dispositivo V de alineación

**TTVA91671**



**FREIGHTLINER**

OEM 1619167001  
Barra en "V" de 56"

**TTVA91670**



**FREIGHTLINER**

OEM 1619167000  
Barra en "V" de 56"

**TTVA3683**

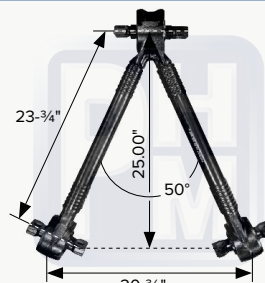

**MERCEDES BENZ / MAN**

OEM 3683500205, 2V5-511441E  
Barra en "V"

**PHM-7-3456**



Cabeza tensor soldable

**PHM-3-3456**

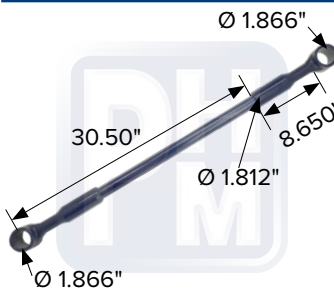

**HENDRICKSON**

OEM 66610  
Tensor para soldar buje de torsión 2"

**PHM-3-3457**



**HENDRICKSON**

OEM  
Tensor fijo para soldar buje de torsión 2 3/4" diametro

**PHM-1-1177**



**HENDRICKSON**

OEM K195-375  
Tensor fijo de 24" para granada de 2-3/4"

**PHM-1-1179**



**HENDRICKSON**

OEM C651009, C651008  
Tensor fijo de 20-1/4" para granada de 2-3/4"

# MÁS DE 65,000 PIEZAS EN STOCK PARA TU CAMIÓN

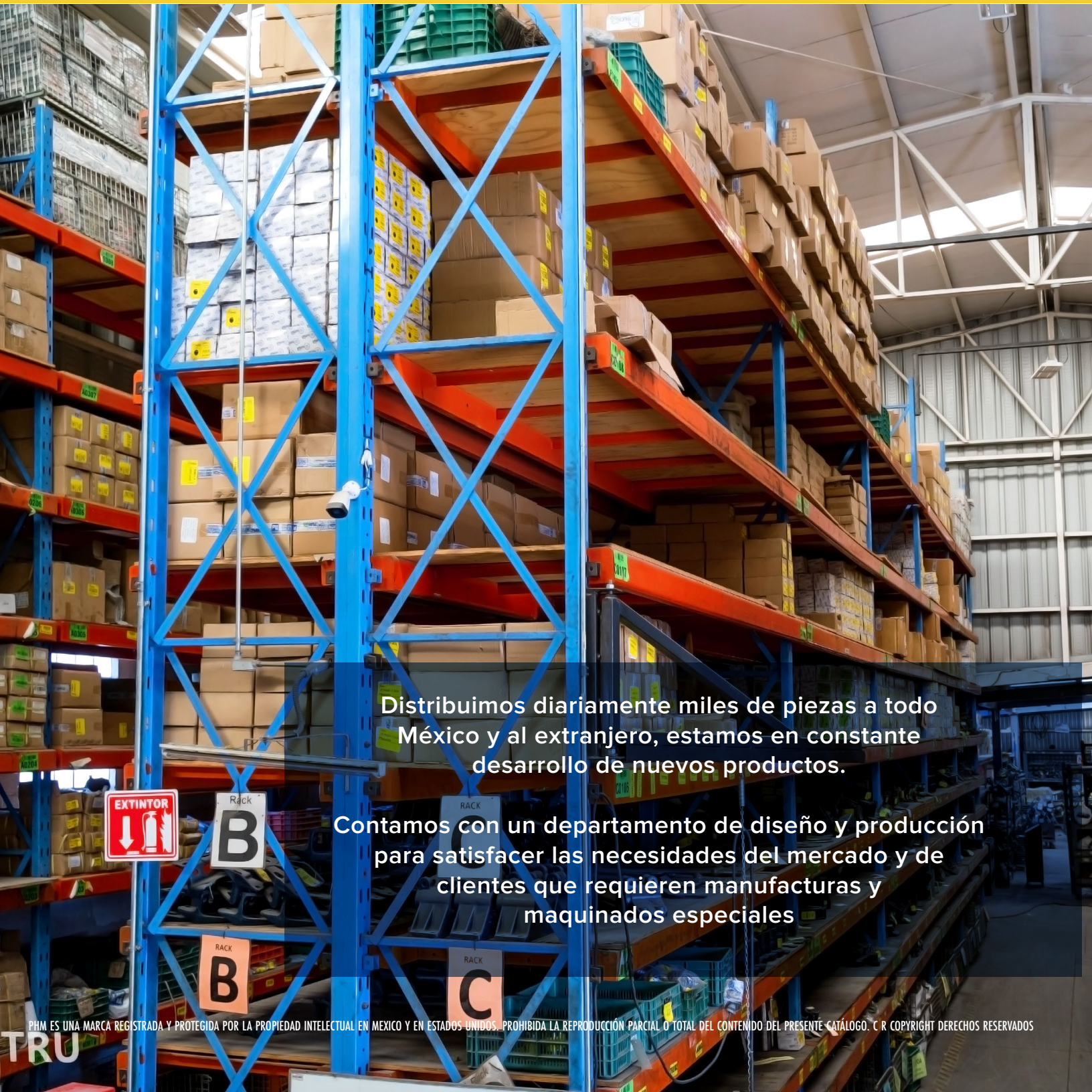

Distribuimos diariamente miles de piezas a todo México y al extranjero, estamos en constante desarrollo de nuevos productos.

Contamos con un departamento de diseño y producción para satisfacer las necesidades del mercado y de clientes que requieren manufacturas y maquinados especiales

### PHM-7-B312570



OEM  
Buje milimétrico bimetálico

### PHM-7-B463889



OEM  
Buje milimétrico bimetálico

### PHM-7-BB003

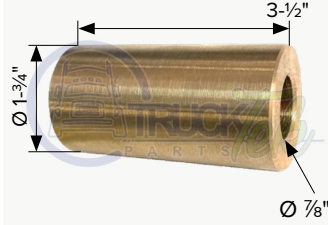

OEM  
Buje de bronce

### PHM-7-2268

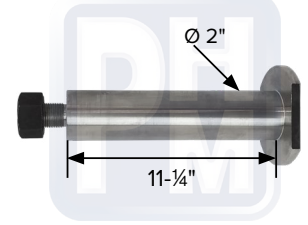

**HOLLAND**  
OEM UXA0015001  
Perno para balancin

### PHM-7-5296



**KENWORTH**  
OEM B131002, 52270  
Buje roscado

### TTHK149

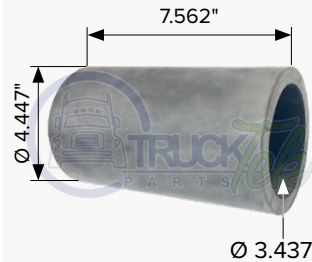

**MACK**  
OEM 10QK149  
Buje para muelle tipo Mack

### PHM-3-1535



**INTERNATIONAL**  
OEM 501535C2  
Rodillo para percha PHM-1-4001 de Nylon tipo International

### PHM-3-0018



**VILCHIS**  
Buje para suspension tipo Vilchis

### TTH2181



**FREIGHTLINER**  
Buje de hule-metal para muelle y percha

### TTH2182



**FREIGHTLINER**  
OEM 1620508000, 1622182000  
Buje de hule-metal para muelle y percha

### TTP0016

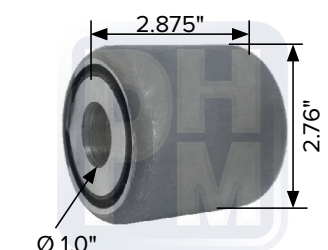

**NEWAY**  
OEM 90008264  
Buje para barra angular de 2-3/4" X 1"

### TTPC1360

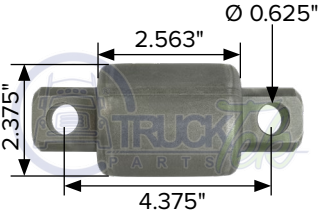

**KENWORTH**  
OEM C136001  
Buje de torsión de alto confinamiento

### TTHR328

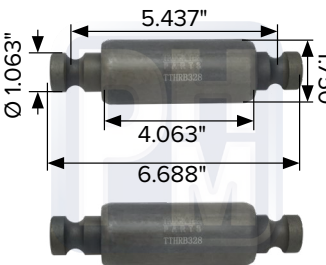

**VOLVO**  
OEM 170107796

### TTHR3295

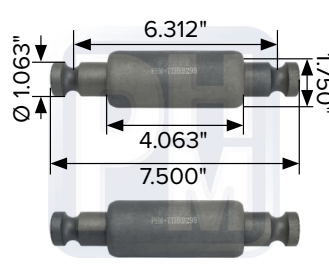

**BENDIX**  
OEM 5016364

### PHM-7-KITRTE94



**HENDRICKSON**  
OEM 30437000  
Juego de bujes de bronce centrales de 3-1/2"

## PHM-7-1400



**FREIGHTLINER**

Juego de tuercas y seguro para M2

## PHM-3-9031

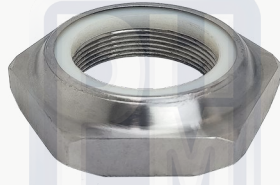

Tuerca hexagonal de 2-1/4" -12 hilos con nylon incluido

## PHM-3-TC0920

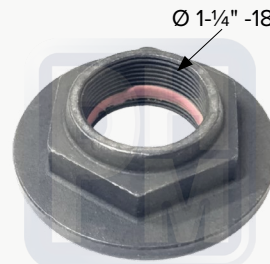

**EATON**

OEM 4301920

Tuerca de seguridad

## PHM-3-TC0988



**EATON**

OEM 127588

Tuerca de seguridad "T" spicer

## PHM-3-3206

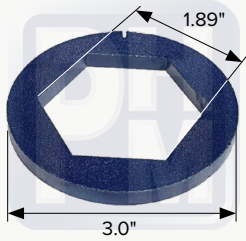

**RIDEWELL**

OEM

Seguro para tornillo de suspensión tipo Ridewell

## PHM-3-W308

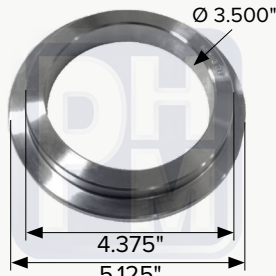

**MACK**

OEM 8QD254M

Rondana

## PHM-3-3786

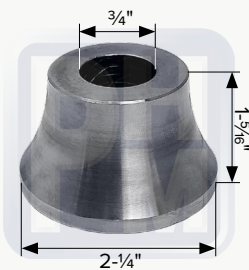

**HENDRICKSON**

Separador de amortiguador tipo Hendrickson Intraax - Vantraax

## PHM-CA39043



Tuerca para diferencial

## PHM-3-8880

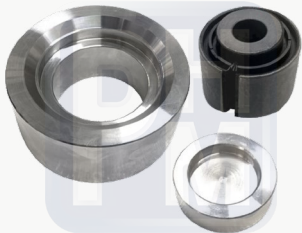

**MERCEDES BENZ**

Juego de herramientas para instalar buje de porteria

## PHM-7-8021



**FRUEHAUF**

Buje para reparación de dolly y percha

## PHM-7-0179

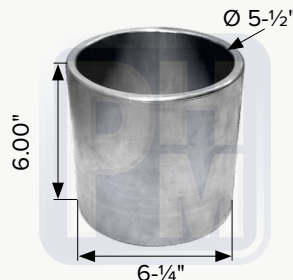

**HENDRICKSON**

Buje de reparación piernas para buje trifuncional grande tipo HT300

## PHM-7-0180



**MERITOR**

Buje de reparación de piernas para buje trifuncional grande

## PHM-7-7720

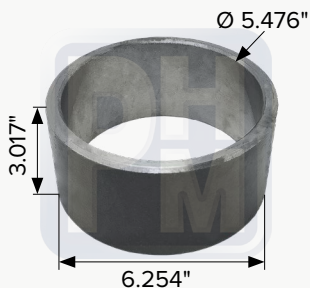

**HENDRICKSON**

OEM

Casquillo trifuncional corto tipo Hendrickson

## PHM-7-8860

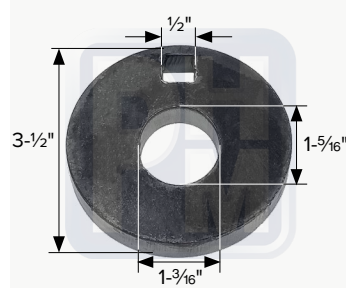

**HENDRICKSON**

OEM

Rondana alineacion suspensión tipo Hendrickson HT-300

## PHM-3-R005

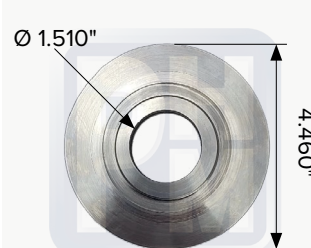

**HENDRICKSON**

OEM

Rondana de alineación de acero soldable

## PHM-7-R999

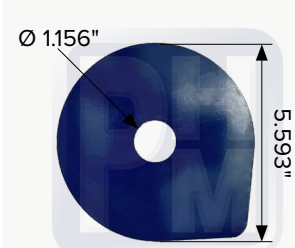

**NEWAY**

OEM 90034537

Rondana alineación



**PHM-TTC632651 X-2**



Yugo deslizable 16 estrías 5-280X

**PHM-TTC632671 X1**



Yugo deslizable

**TTC8221 X-2**



YUGO A250 82 21X-2 OREJA  
Ensamble yugo SPL 250

**TTC628347-1**



Yugo soldable de 4"

**PHM-7-NT0812**



Nudo toma de fuerza 13/16" x 13/16" con cuñero 1/4"

**PHM-7-NT0937**



Nudo toma de fuerza 15/16" x 15/16" con cuñero 1/4"

**PHM-7-SK00198**

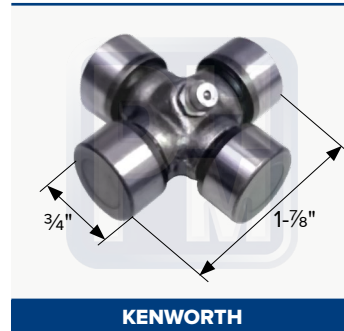

**KENWORTH**

Cruceta de dirección

**PHM-7-SPL1808**

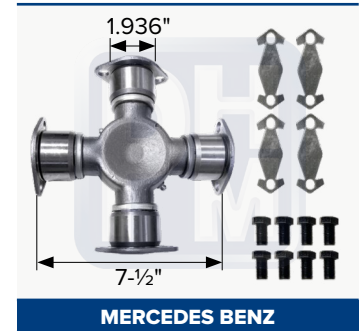

**MERCEDES BENZ**

Cruceta de dirección

**TTH0220**



**CHEVROLET**

Goma para soporte Cardán 509

**TTH0226**



**DINA**

Goma para soporte Cardán 510

**PHM-TTC640541-1**

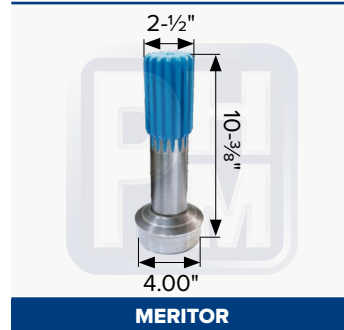

**MERITOR**

OEM 6-40-541

Espiga cardan deslizable de 16 estrías

**PHM-TTC640521**

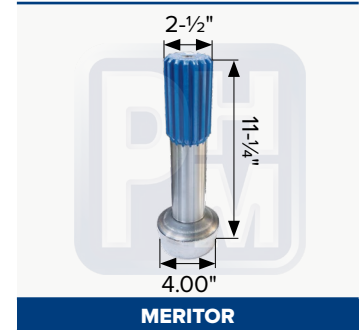

**MERITOR**

OEM 6-40-521

Espiga cardan deslizable de 16 estrías

**PHM-7-HMFL001**

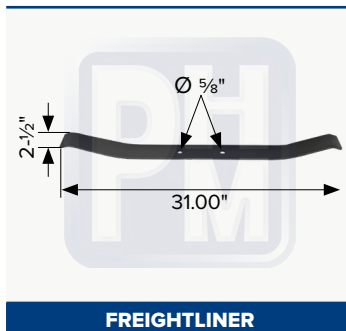

**FREIGHTLINER**

Soporte muelle de transmisión

### 7R760

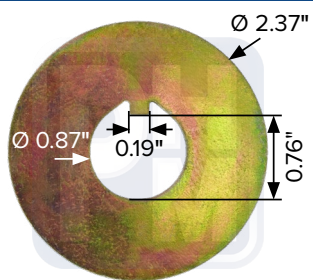

OEM  
Rondana de mango delantero

### 7R637

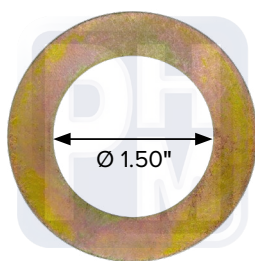

**MERITOR**  
OEM 1229T1736  
Rondana de eje

### 7R437

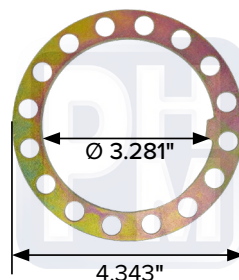

**MERITOR**  
OEM  
Rondana de eje

### 7R339

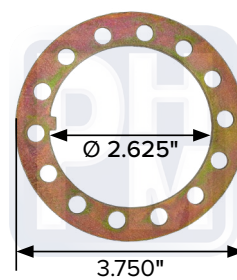

**MERITOR**  
OEM 1229G1021  
Rondana de eje

### TTP2122

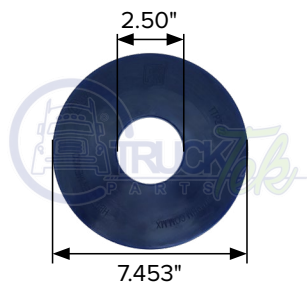

**MERITOR**  
OEM 21226663  
Rondana de desgaste para meritor

### 3H003

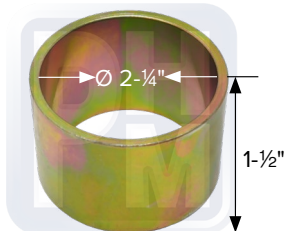

**HENDRICKSON**  
OEM 66086001  
Herramienta para instalar bujes 2" sin casquillo



**LA FUERZA, ENTREGA  
Y DEDICACION  
NOS CARACTERIZAN**

<https://www.phm.com.mx>

Nos aseguramos que nuestros productos cumplan con el más mínimo requerimiento para una calidad superior.



**TTU10**



**SURTEK**

Llave para quitar filtros universales 3-7/16" a 3"

**TTULF2000**



Llave para quitar filtros universales 3-7/16" a 3"

**PHM-7-LLESPE2**



Espatula plana doble cuchara de 25"

**ZWD40**



Lubricante WD40 de 382 g /469 ml.

**ZZ84**



Toallas para limpieza de manos quita grasa y aceite

**A646177**



OEM

Amortiguador eje auto dirección montaje superior ES36

**PHM-3-IHCOMCR**

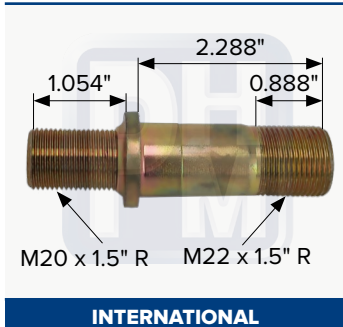

**INTERNATIONAL**

OEM

Birlo derecho

**PHM-3-IHCOMCL**



**INTERNATIONAL**

OEM

Birlo izquierdo



**FABRICAMOS CALIDAD  
DE CLASE MUNDIAL**

## NUESTRO PROCESO

### DISEÑO DE PRODUCTO

Investigamos el mercado para producir los productos que requiere o los producimos según especificaciones de nuestros clientes

01

### FABRICACIÓN

Después de generar el diseño se coloca en nuestra línea de producción donde nuestro personal calificado y capacitado opera la maquinaria para manufactura

02

03

### CONTROL DE CALIDAD

Diferentes departamentos se aseguran que los productos cumplan los requerimientos técnicos de medida, además de someterse los materiales a pruebas de factibilidad y resistencia

04

05

### SERVICIO Y VENTA

Nuestros diferentes canales de venta disponibles proveen un el trato capacitado en el sevicio con calidad humana

### ALMACENAJE

Almacenamos los productos con cuidados para que sus cualidades no se deterioren ni se maltraten

06

### DISTRIBUCIÓN Y ENVÍO

Las ordenes se procesan el mismo día y se gestiona que lleguen en el menor tiempo posible a nuestros clientes



TECNOLOGÍA DE VANGUARDIA



Carretera a Nógales #13900 km. 14 local 7  
San Juan de Ocotán C.P. 45019  
Zapopan, Jalisco  
Teléfono: **3321839171**

En **PHM**® Somos distribuidores exclusivos de productos **TRUCKTEK**®, empresa mexicana que comparte nuestros valores y objetivos.

En **TRUCKTEK**® se fabrican y se importan productos de hule y principalmente poliuretano con altos estándares de control de sus cualidades de resistencia y durabilidad, productos de los más importantes para la suspensión de tu camión como lo son bujes, pernos, rondanas y arandelas.



## GARANTÍA

PARTES HERRAMIENTAS Y MAQUINADOS, S.A. DE C.V. garantiza todos sus productos (Partes de Repuesto PHM®) contra cualquier defecto de fabricación en sus materiales y mano de obra, siempre y cuando se cumplan con las especificaciones de aplicación, uso e instalación.

La responsabilidad de PHM® en esta garantía está limitada al reemplazo de las partes encontradas defectuosas, mismas que deberán ser enviadas (flete prepago) a nuestro domicilio para su inspección por el departamento técnico de PHM para determinar y evaluar la procedencia o no de la garantía.

La responsabilidad de PHM®, queda limitada a lo expresamente especificado en esta garantía y no incluye daño directo, indirectos o consecuenciales.

## RECTIFICACIÓN

Los nombres y números de referencia de fabricantes de este catálogo son únicamente para ayuda en la identificación de los productos y en ningún momento implica que los productos son de dichos fabricantes.

Las dimensiones del producto son las comerciales y pueden variar ligeramente con las reales.

Aunque se ha tenido especial cuidado con la veracidad de los datos de este catálogo PHM® no asume ninguna responsabilidad por errores u omisiones



**SUSENSIONES Y  
REFACCIONES**



**TECNOLOGÍA DE VANGUARDIA**

Partes Herramientas y Maquinados, S.A. de C.V.  
Calle 28 #2774, Zona Industrial, C.P. 44940  
Guadalajara, Jalisco, México

**Datos de contacto**

☎ 33 3145 1011  
☎ 33 3145 1884  
☎ 33 3145 1876

☎ 33 1254 7813  
☎ 33 1461 0175  
☎ 33 2184 3148  
☎ 33 2615 1393  
☎ 33 1263 5401

✉ [ventas@phm.com.mx](mailto:ventas@phm.com.mx)  
✉ [contacto@phm.com.mx](mailto:contacto@phm.com.mx)  
🌐 <http://phm.com.mx>